

RESPIRO R3 & R3.5

# SMOOTH FORAGE RAKING



**REITER**  
www.reiter-respiro.com

# RESPIRO

This is the future of raking



DI Thomas Reiter, Founder and Managing Director

## Never drive over the forage again

Cleanest forage

With conventional roundabout rake technology, the forage is pushed into the ground in the tractor track, this leads to increased dirt accumulation, raking and crumble losses. With **RESPIRO** front-belt rakes, these disadvantages are eliminated because they never run over the forage again! This is the only way to achieve unique forage quality and fewer losses. Practitioners confirm the outstanding work quality, achieved by the flexible pick-up and the dragging tine. **The multiple positive effects of clean forage create the added value that makes this technology a highly profitable investment.**

## THE PICK-UP REVOLUTION: BEST SOIL ADAPTATION

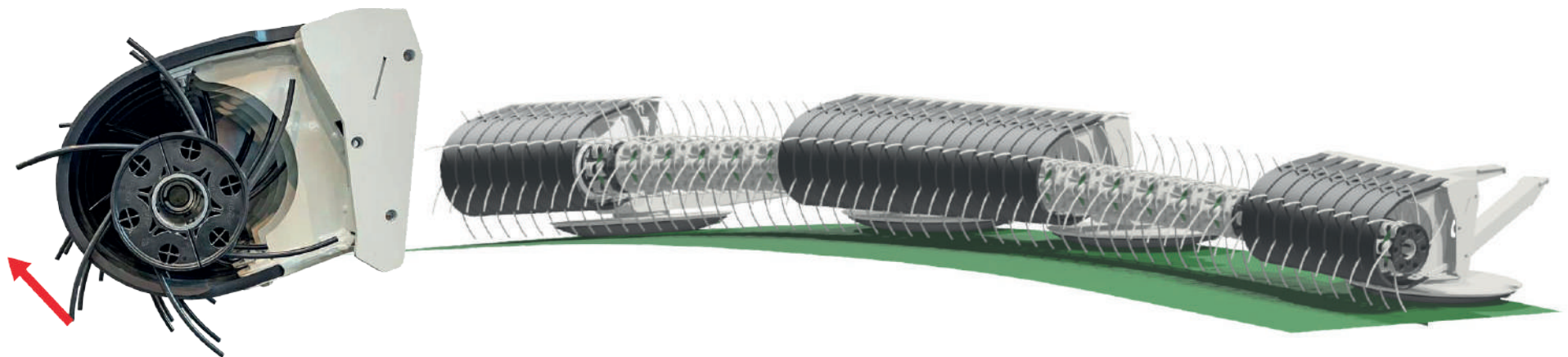



Photo: Poelman Robbe

QUALITY. PROFIT. JOY.

**PICK-UP WITH**  
 DRAGGING TINES,  
 SMALL PICK-UP DIAMETER  
 & FLEXIBLE PICK-UP

## Table of contents

Sweeping versus lifting	... 4
The future of raking	... 5
Added value for the farmer	... 6
Increase in forage productivity	... 8
Added value & versatility	...10

Flexible pick-up	... 12
Sliding disc close to the tine	... 13
Trailing tine	... 14
Anti-Loss-System	... 15
Camless pick-up	... 16
Small diameter	... 17
Conveyor rotor & swath roller	... 18

<b>RESPIRO</b> R3 / R3.5 compact	... 20
<b>RESPIRO</b> R3 / R3.5 profi	... 21
Operation & data sheet	... 23

[www.reiter-respiro.com](http://www.reiter-respiro.com)

Cleanest forage

The technology

RESPIRO compact & profi

# Is sweeping with the rotary rake still up to date?

*How much longer are we going to go without extracting the full value of the basic fodder?*

The lines in the picture illustrate the enormous succession of tines when swathing and the long path when sweeping the crop on the ground.

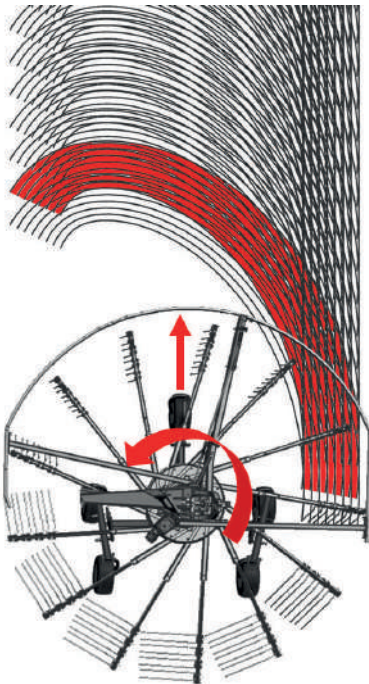

**Rotary rake:** In practice, frequent and aggressive ground contact is unavoidable: Dirt and foreign matter ingress with all the known disadvantages.

## Inevitable consequences due to contaminated feed!

### Deficits in performance

- ▶ Compacted / knotted swath
- ▶ Limited working speed
- ▶ Poorer post-drying on the swath
- ▶ Inflexible in working width and depositing direction

### Animal health risks

- ▶ Contaminated feed causes inflammation, fertility and hoof problems
- ▶ Less performance
- ▶ Colics in horses

### Contaminations

- ▶ Dust, soil, sand
- ▶ Stones and foreign objects
- ▶ Unhelpful bacteria and fungi
- ▶ Slurry / manure residues
- ▶ Mice
- ▶ Rotten undergrass

### Losses

- ▶ Leaf loss
- ▶ Crumbling losses
- ▶ Rake losses
- ▶ Losses at the feeding fence
- ▶ Wear on machinery

**Never drive over the forage again  
BECAUSE, THIS IS THE NEW WAY.**



Cleanest forage

## **RESPIRO**

exploits the full potential

If you make cleanest forage your top priority,  
is to move from sweeping to lifting.



### **Clean forage**

Noticeable reduction of all kinds of contamination = best forage quality

### **Animal Health**

Better feed keeps animals healthy, less worry, more success

### **High performance + flexibility**

Loose swath, no twisting, high working speed, full flexibility in working width, left and right delivery possible

### **Lowest losses**

Less leaf loss improve protein content, very little wear

### **For all uses**

Ideally suitable for difficult working conditions

Never drive  
over the forage  
again.

## RESPIRO R3 & R3.5

Invest in the right technology now.

CLEAN. ENERGY-RICH. VALUABLE

Compared to conventional rotary rake technology, the **RESPIRO R3 / 3.5 compact | R3 / 3.5 profi** never drives over the forage.

The pick-up of the machine can be set higher, as nothing has to be “tickled” out of the tracks. Less ground contact, fewer stones and dirt in the forage.

The driver has full visibility of the machine and can therefore relax during a long working day. Swaths can be placed perfectly next to each other, as the driver can see directly on them.

**Perfect swathing of the field corners** - swath out to the last corner with the belt stopped and then carry the forage on the belt into the field.

High area output despite relatively small working width

Driving speeds of up to 25 km/h  
depending on field conditions with clean,  
loss-free forage collection.



from the practice

**Ruben D.**

Farmer from Niedersachsen  
(RESPIRO R3.5 compact)

**RESPIRO** customer since 2019

*“The veterinary costs of our 108 cow herd  
have decreased by € 50 / cow & year. Milk  
yield has increased by more than 10% from  
9,600 kg to 10,600 kg / cow & year!”*

# **RESPIRO** technology creates benefits that our customers never want to do without again

## **Swath fluffy, even, perfect size**

- ▶ Looser placement, better drying - earlier start of the swath possible
- ▶ Even swath for high output of the following harvesting machine
- ▶ Always the right swath size for the following harvester ... Lifting over the swath several times is not a problem

## **Less forage contamination**

- ▶ Machine can generally be set higher, because the forage does not have to be scraped out of the ground.
- ▶ Lower crude ash, more energy, more protein → Higher milk yield
- ▶ Better fermentation quality, tastiness → Higher forage intake
- ▶ Best forage quality ensures animal health → Lower veterinary costs
- ▶ Higher herd age.

## **Lower losses**

- ▶ Less leaf losses, more crude protein → Ideal for legumes
- ▶ Less crumble losses delivers more output from the forage
- ▶ More crop yield per ha due to less raking losses
- ▶ No lying rotting grass
- ▶ Higher lifetime performance of machinery
- ▶ Lower repair costs.

## **More advantages**

- ▶ Flexible cleaning out of corners and pointed fields by loading the stopped belt
- ▶ Lower wear due to few stones and foreign objects in the forage
- ▶ Protection of the swath \*No broken tines in the forage



from the practice

**Markus M.**

farmer from Horgenzell, DE  
(RESPIRO R3 compact 700)

**RESPIRO** customer since 2017

*“30 dairy cows and bull mast, Fleckvieh, barn average 9500 kg, 80% grass, hay drying. Big problems with mice infestation on the fields. With the RESPIRO he “sieves” the dirt out properly. After pressing the hay from the hay dryer, almost no dirt remains under the press and thus everything can be fed. Since then, the cows give 2 litres more milk per day.”*”



# Increase in forage productivity

HEALTH.FERTILITY.LIFE PERFORMANCE

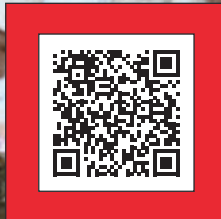

## The goal: reduction of crude ash content

With the **RESPIRO**, thanks to the flexible pick-up and the trailing tines, a reduction of the crude ash content by up to 40 g/kg DM is possible. Clean forage is the basis for increasing forage productivity. The more difficult the harvesting conditions, the greater the potential for productivity increase through the use of **RESPIRO** technology.

## Rule of thumb: Milk production

- ▶ The reduction of 10 g raw ash/kg DM in the feed increases on average...
  - ▶ ...the energy concentration (NEL) by about 0.1 MJ/kg DM
  - ▶ ...the crude protein content (XP) by 1.6 g/kg DM
- ▶ Energy requirement of the cow for milk production: 3.17 MJ NEL/kg milk

## Enormous potential

Reduction of crude ash content with the **RESPIRO** technology

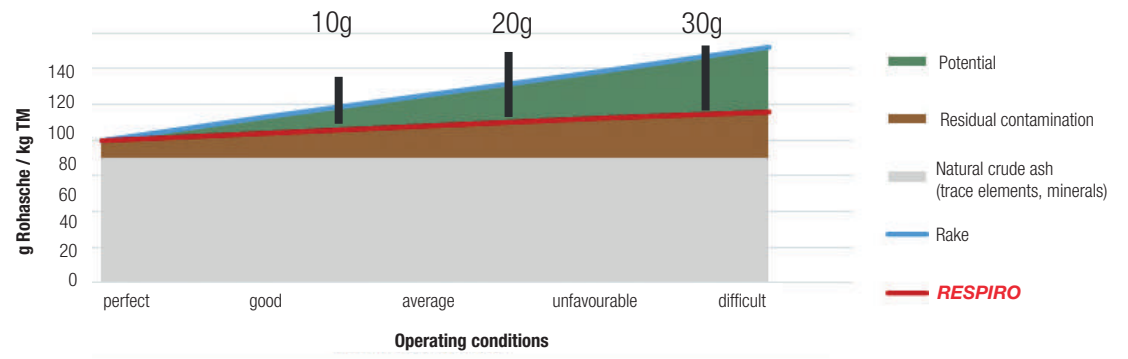



# 1 Higher feed value

Dirt displaces valuable energy and protein in the feed. If you reduce the amount of dirt, the cow automatically takes in more energy and protein when eating, **thus increasing the amount of milk.**

EXAMPLE

## Additional yield per cow\*

- 0,5 kg milk / day
- 150 kg milk / year
- 60 € / cow & year

Savings of 15 kg soy / cow & year = 6 € / cow & year  
Each cow eats 60 kg less dirt & year !!!!!

# 2 Increase feed intake

Clean fodder is tastier, the cows are more energetic due to less dirt in the fodder and this increases their appetite. The daily feed intake increases and so does the amount of milk.

▶ 0.33 kg DM / day higher basic feed intake

EXAMPLE

## Additional yield per cow\*

- 0,63 kg milk / day
- 188 kg milk / year
- 75 € / cow & year

INTERIM STATEMENT

## PROFIT POTENTIAL\*

Higher feed value: 60 € / cow & year  
+ Soy saving: 6 € / cow & year  
+ feed intake 75 € / cow & year

**141 € / cow & year**



## Calculation 30 cow farm

- 4,230 € additional income / year

---

- 1,800 kilogram less dirt in the feed

EXAMPLE

# 3 Other profitable factors

- ▶ Lower veterinary costs
- ▶ Fewer worries in the barn
- ▶ Higher vitality, higher herd age
- ▶ Lower field losses
- ▶ Better ensiling, less fermentation losses
- ▶ Savings on silage additives
- ▶ Less feed loss at the feed table
- ▶ and much more...



# Less crumb loss

more protein in the feed

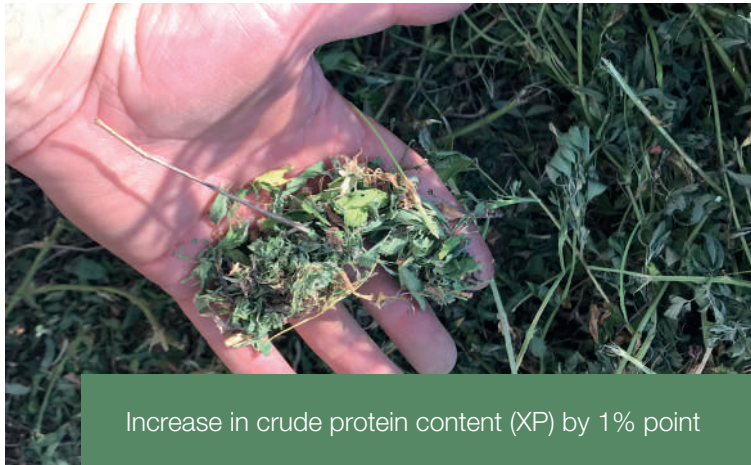

EXAMPLE

## Additional yield per hectare\*

- 100 kg more crude protein / ha & year
- 80 € additional yield / ha & year

Cows  
would buy  
**RESPIRO**



Especially for sensitive forage crops with a high leaf content (clover, alfalfa), the **RESPIRO** technology is better suited than conventional systems on the market.

### The following aspects are decisive for this:

- ▶ Forage plants are lifted very carefully on the spot, and not swept over the entire surface
- ▶ Small pick-up diameter → low barrier, the crop mass is lifted smoothly
- ▶ Low tine impact speed → protection starts at the pick-up
- ▶ Forage is transported to the belt by the rotor: forage-friendly compared to belt rakes with a large pick-up diameter, where the throwing energy is generated by the high tine speed.

# Flexibility and diversity of use

## Perfect swaths from the first to the last cut

With a variety of driving strategies, efficient harvesting of sufficient mass for the harvesting chain is achieved: Fewer passes of the harvesting chain - higher efficiency - lower diesel consumption - less soil compaction. Due to the small pick-up diameter and the feed rotor, repeated overlifting is no problem.

- ▶ **No increase in forage contamination**
- ▶ **The swaths are laid down fluffily**
- ▶ **Better post-drying, higher driving speed of the harvester.**

In comparison, the rotary rake compacts the crop and leads to worse post-drying.



## Diversity of use

**RESPIRO** technology is ideally suited for all applications:

**Grassland, forage, alfalfa, straw, maize straw, from long horse hay to short last cut in permanent grassland**



# Unique

## The flexible pick-up from Reiter

The flexible pick-up is the heart of the **RESPIRO** belt rake.

With pick-up widths of 3 m and more, the pick-up must be flexible so that the ground adaptation works. This is the only way to achieve perfect work result in grassland.

This unique position points the way to the future of belt rakes.

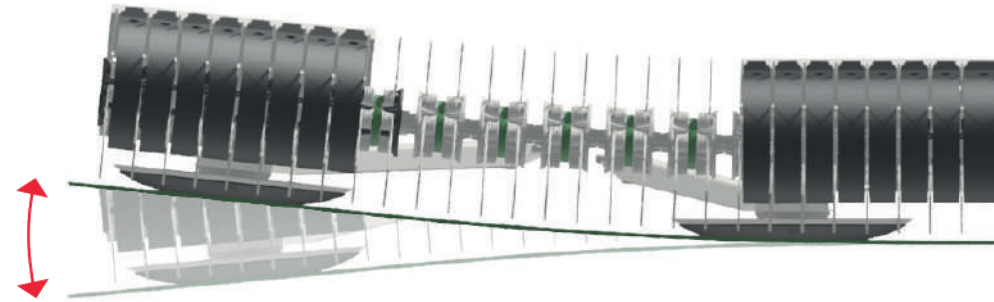

**Due to the unique flexible pick-up in the **RESPIRO**, we achieve unprecedented ground hugging. Even forage from deepenings is picked up cleanly and without loss.**

### Best raking quality

Even under difficult working conditions, raking losses are low. This not only increases the overall yield but also the forage quality of the subsequent cuts. Top quality - hectare by hectare, cut by cut.

### No aggressive ground contact

Due to the flexibility of the pick-up, no aggressive ground contact is possible. This not only creates a good feeling in operation. It is the basis for top forage quality. The sward is also protected, which promotes re-growth.

### Little wear on the tines

The pick-up tines only touch the ground sporadically. This minimises wear on the tines. That's what every practitioner wants.

### Few tine breaks

The dragging pick-up tines very rarely touch the ground. The logical consequence is maximum tine life.

### In detail

The pick-up is divided into several segments - the two middle sliding discs guide the pick-up inside and support the belt body - the two outer sliding discs only guide the outer pick-up segments in height. The elastic spine attached behind the Pick-Up connects the five-part structure of the yokes and keeps the Pick-Up in shape - this enables perfect ground hugging.

Elastic spine  
**PATENTED**

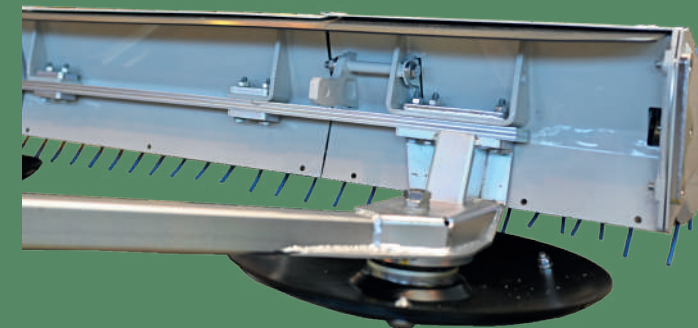

# Best ground guide

## Sliding discs close to the

The sliding discs are positioned as close as possible to the tine rake line. They guide the pick-up perfectly over the ground without leaving marks. Punching into the soil is virtually impossible. That is why the Respiro belt rake has no fixed skids.

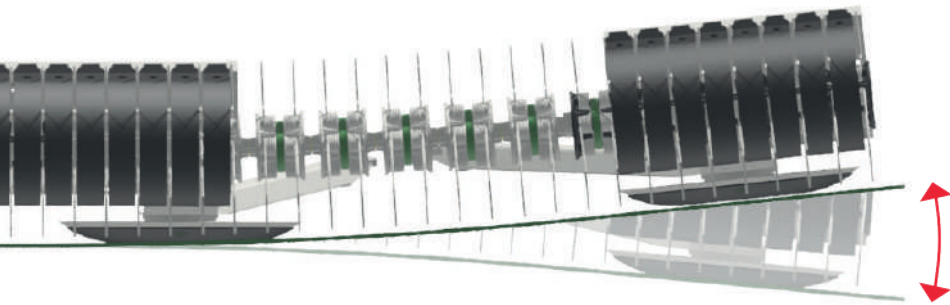

### Free rotating

Protection of the turf and soil, even wear over the entire area and easy glide trough of foreign objects, soil and stones to the left or right of the sliding disc, as it is almost constantly in rotation.

### Large contact surface

The large contact surface has a damping effect and thus reduces system oscillations and vibrations. Holes in the ground do not cause the pick-up to sag and thus ensure an ideal working result.

### Simple wear part

The base plate carries the wear plate. The wear plate, made of hardened boron steel, is simple and cost-effective. This ensures that wear costs remain low even in difficult, hard ground conditions



Via the truss, the forces are transmitted into the back



# Leave Stones

## Trailing tines

Next to the flexible pick-up, the trailing tines are the most important component for the cleanest forage. The tines are arranged dragging on the rake line, which means they react passively when they come into contact with the ground. Forage is picked up cleanly, dirt, soil, stones and foreign objects remain on the ground.

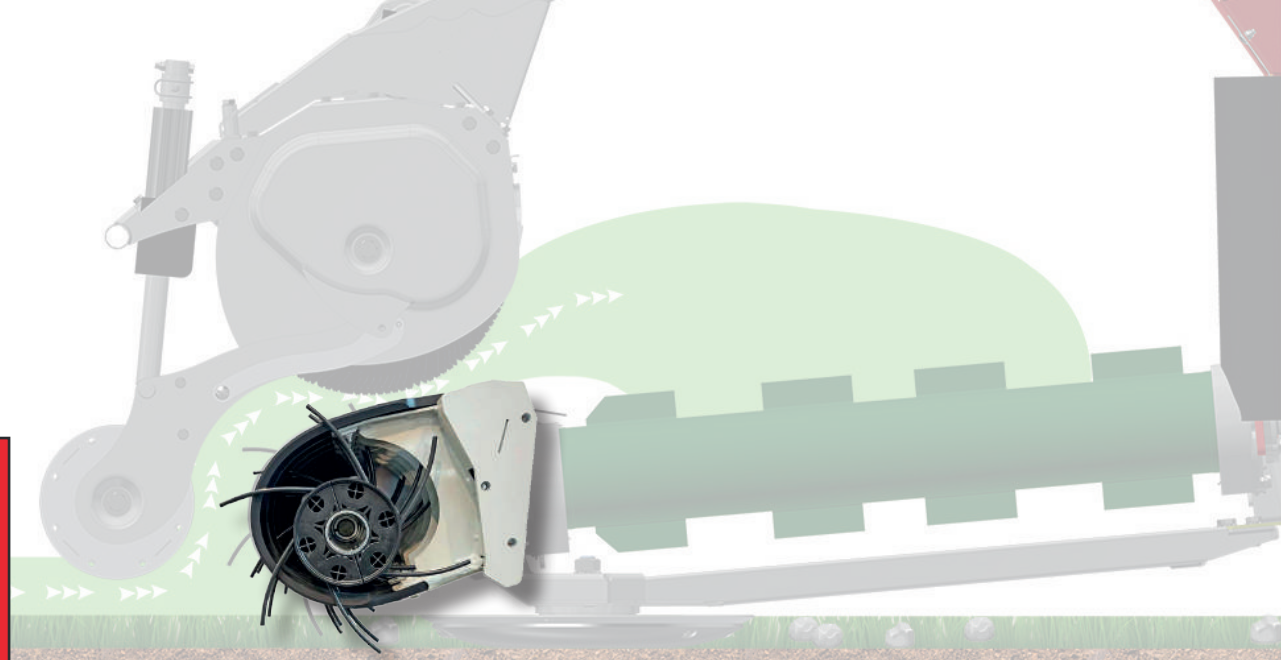

### No aggressive ground contact possible

Due to the trailing geometry, aggressive contact with the ground contact is not possible at all. For short bumps, etc., additional ground adaptation can be achieved. This protects the whole system.

### Stones and foreign bodies remain in place

Contact with stones and foreign bodies is repellent. As a result, they remain on the field. There are no stone splinters in the forage. The following harvester is protected.



### Tine legs do not bend when cornering

**RESPIRO** Pick-Up technology has virtually no bent tines. The dragging geometry is the reason for this. A thankful advantage in practice. Tedious tine alignment is a thing of the past.

### Plant stems are not uprooted

This is particularly important with maize straw. Stalks cannot be uprooted, so neither stones nor soil get into the straw. Ideal for minimising wear on subsequent cutterbars.

### Less wear and breakage

Due to the low load on the tine legs there is significantly less wear. The tines are protected and have a very long service life.



**Anti-Loss-System  
patented**

# Simple & safe

## Anti-Loss System

The dream of every technician : to have to screw as little as possible to the pick-up.  
The Anti-Loss System fulfils this dream and makes it possible.



The technology

### Unique tine mounting

A single M8 bolt secures 6 double tines.  
Changing the tines is simple and quick.

### Tines broken in the winding are not lost

In the event of a broken coil, the tine remains suspended in the support. Thus, broken tines run in circles without consequential damage - replacement at the next opportunity is sufficient.

Image: Slurry particles, stones and dirt remain on the ground

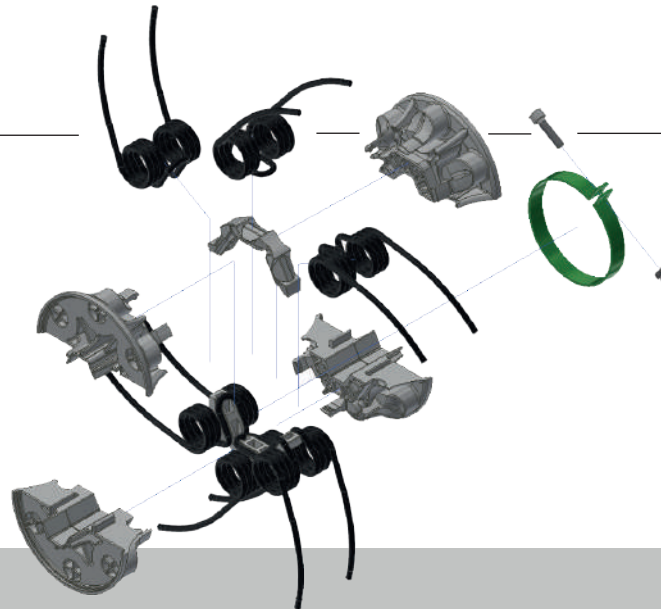

### Tine winding is supported from the inside

Another feature of the ingeniously simple solution: the tine winding is solidly supported from the inside. This guarantees an extremely long service life of the tines.

# Convincing Simple

## The camless pick-up

A belt rake has many metres of pick-up. With conventional systems, a large working width means that several cam tracks have to be installed. That is not the future of the belt rake. A new concept is needed. Easy maintenance demands a camless system. The **RESPIRO** technology is the first belt rake with a camless pick-up, a real milestone.

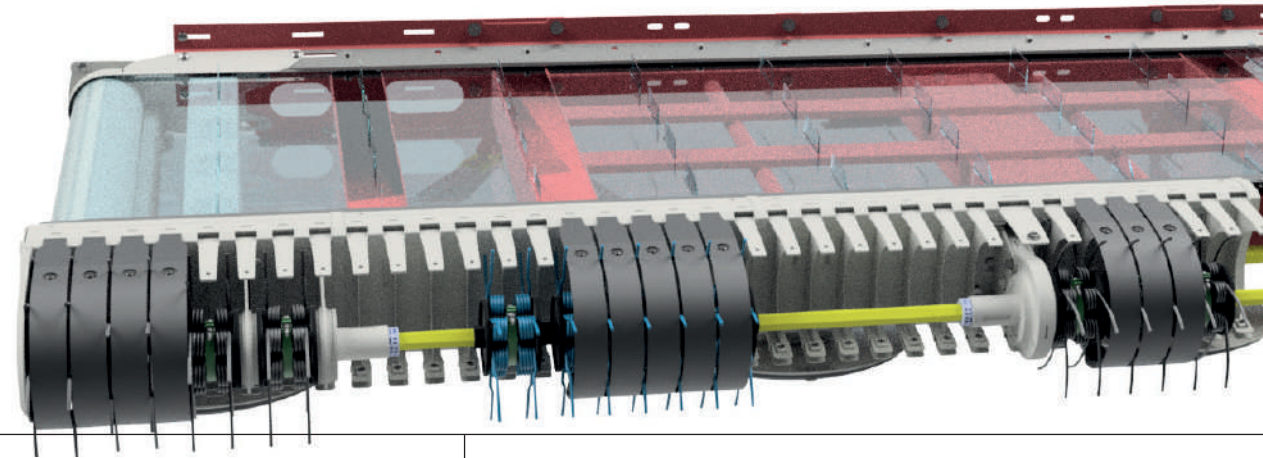

**maintenance-free!**

### Radically simply built

Simple rotation, no additional moving parts, no additional wear and tear. Compact, robust, reliable, simple. Built for practice.

### Significantly fewer components

A central axle with a hexagonal profile transmits the power to the tine carrier discs. No unnecessary bearing points, control rollers, cam tracks and tine carrier profiles. Why complicate things when they can be so simple?

### Centre drive with 2 double bearing units on each side

The torque of the pick-up shaft is halved. The centre drive with gears is maintenance-free.

### No axial movement

Another significant technical plus point. The precise mounting of the pick-up tines combined with the axially backlash-free design of the fully loaded pick-up shaft reduces lateral wear between the pick-up tines and the scraper. A well thought-out overall system.

### Allows small diameter

Little crop spread over the area - that is the highest challenge for a pick-up system. Only the small diameter opens the door for an uncontrolled, simple pick-up.

### Tine impact speed

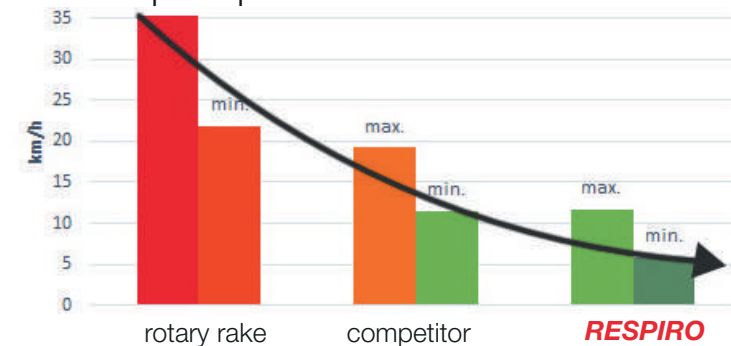



# Gentle & powerful

## Small diameter

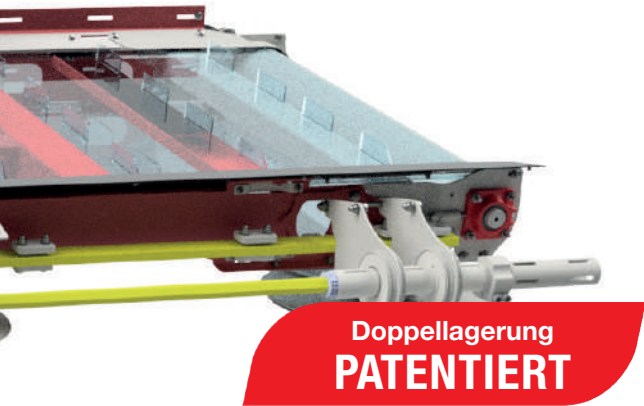

The small diameter, or to put it another way, the low height of the pick-up is another key of the **RESPIRO** technology. The flow of the crop is ideal. The crop flows harmoniously onto the conveyor belt. Convincingly simple and efficient. The performance of the system is amazing. Depending on the operating conditions, working speeds of up to 25 km/h are possible. Despite the high performance, the mechanical stress on the crop remains low. This ensures high protein content through very low crumble losses of valuable leaf mass.

### Small distance between tine rows

The six-row pick-up with such a small diameter delivers a harmonious sequence of tines. The seamless sequence of tines lifts the crop quickly and very gently from the ground. Optimum crop flow is the result.

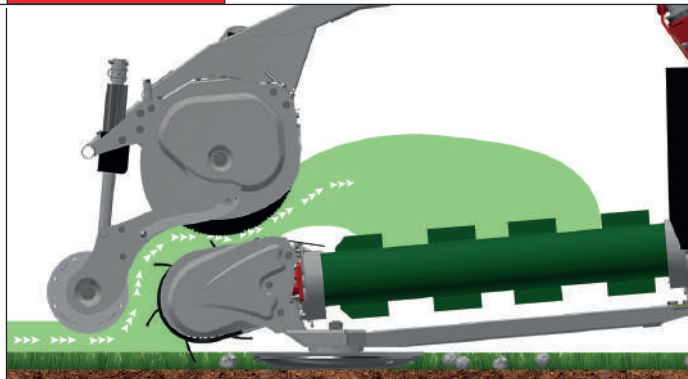

### Powerful even with short forage

The small pick-up lifts the forage out of the stubble immediately and without interruption. This means that even short forage can be raked effectively. This increases the productivity of the **RESPIRO** belt rake enormously.

### Low tine impact speed

Due to the small overall height of the Pick-Up, the tine speed can be kept very low. The crop wave nevertheless floats up, is taken over by the rotor and guided onto the conveyor belt. Especially for legumes and for crops with a high dry matter content. Less leaf loss and more protein.

### Enables the trailing tine

The trailing tine was never "planned". Practice has produced it. Because the diameter of the pick-up is so small, the tines can be dragged. At the height of the mowing horizon, the tines lift the crop dynamically out of the stubble. The secret of the **RESPIRO** system.

### Underruns large swath

When turning swaths and with high harvest yields, the small pick-up has another decisive advantage: the harvest mass floats on the pick-up. Harmonious, powerful and efficient. Despite very high masses, the Pick-Up requires very little drive torque. Ideal for energy efficiency and service life.

# Perfect crop flow

## Conveyor rotor and swath roller

A guided crop flow delivers very high flexibility in operation. Whether the crop is short or long, dry or wet, the working speed high or low, the feed rotor ensures a good flow. This delivers uniform swaths. The key to the productivity of the following harvester.

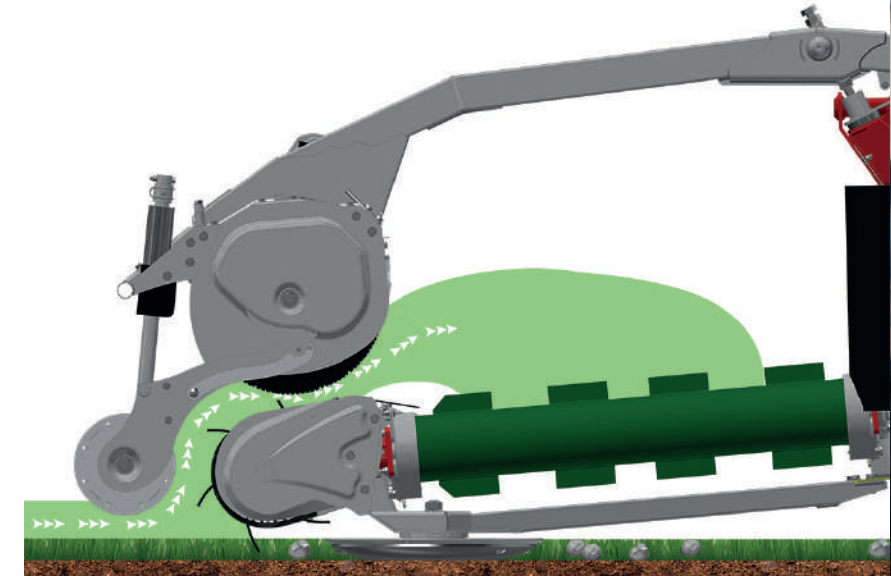

### Ensures a uniform crop flow

The synchronously running elements pick-up and conveyor rotor work hand in hand. The pick-up lifts gently from the ground, the rotor conveys onto the belt. An ideal combination. The conveyor rotor is one of the decisive factors for the high working speed.

### Conveyor rotor hydraulically relieved and height adjustable.

If a lot of mass comes in or a swath is moved again, the rotor automatically moves upwards, thus increasing the swallowing capacity and the performance.

### Swath roller guides the crop flow to Pick-Up

The swath roller allows even very short crops to be picked up from the ground with little loss. Even at the headland, no forage remains in front of the pick-up when it is lifted.

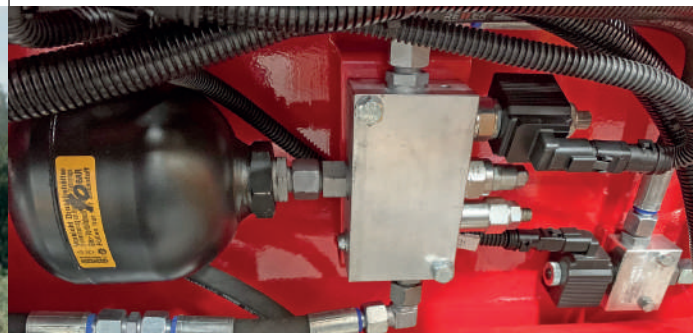

Rotor module: Suspension and damping from the rotor can be adjusted.

### Conveyor belt

#### Belt with split studs

Better conveying effect especially with dry material (hay, straw, lucerne) More even conveying, no pile formation

#### Multi-layer PVC belt with edge reinforcement

- ▶ Longer service life
- ▶ Better lateral stability

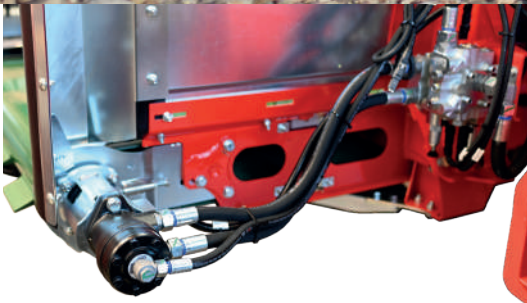

Belt drive is via hydraulic motor OMR with leakage oil line - a coupling for tension-free drive sits in between.

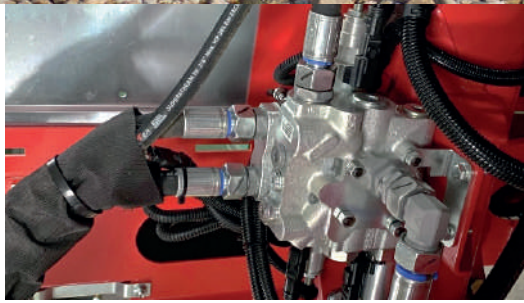

The belt valve determines the depositing direction and the belt speed - both adjustable via the terminal.

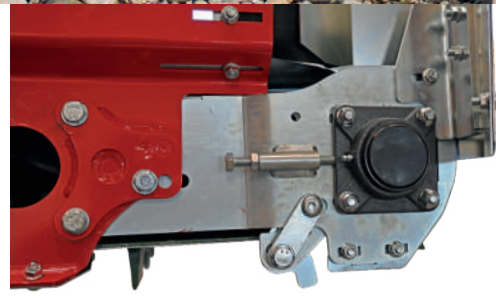

Belt roller bearing via robust standard flange bearings - adjustable scrapers clean the rollers.

# RESPIRO R3 / 3.5 COMPACT

Relief springs to the tractor,  
short attachment



## Centre of gravity close to the tractor

The **RESPIRO** compact is designed for use with smaller 4-cylinder tractors. The short lower link mounting brings the centre of gravity closer to the tractor. When working, the lower links of the tractor rise slightly towards the front implement. This results in a slight upward deflection in the event of uneven ground. Furthermore, the contour adaptation is also influenced by the position of the tractor's lower and upper links. Different pin positions enable exact adjustment to the respective tractor linkage.

The lateral adjustment is made via the swinging lower link rocker cat. II (+/- 15 degrees). Rubber buffers keep the implement centred for transport. The implement is relieved of load by means of 2 large relief springs which are hooked in towards the tractor. The springs are unnecessary on tractors with integrated hydraulic linkage relief.



R3 compact 700  
Very compact design, due to short belt

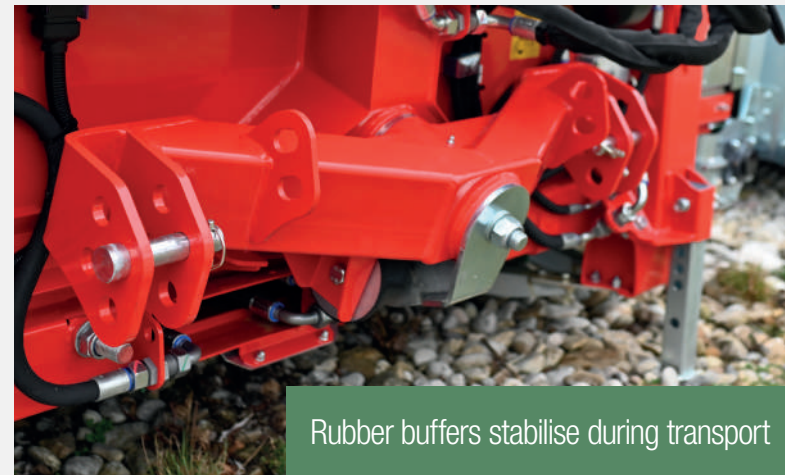

Rubber buffers stabilise during transport

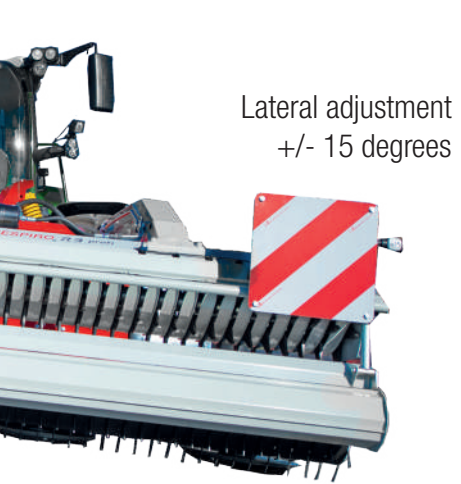

Lateral adjustment  
+/- 15 degrees



# RESPIRO R3 / 3.5 PROFI



*Integrated relief,  
perfect solution also for large tractors*

## Best ground hugging, independent of tractor hydraulics

The **RESPIRO** profi with integrated kinematics with spring relief ensures the best ground hugging independent of the tractor hydraulics. Designed for the hardest use with larger tractors and high driving speeds. The working unit is pushed from below by the lower links rising to the front. Due to the position towards the upper link, the instantaneous pole (IP) of both force lines is below ground level. This has the effect that the working unit is lighter when operating at higher speeds and can thus more easily move upwards when the ground is uneven. This kinematics also ensures contour adjustment in the longitudinal direction and thus constant raking height.

A lateral adjustment of +/- 15 degrees is possible. The generously dimensioned, long relief springs ensure fast reaction speed and even contact pressure. Protection of the sward and less wear from the sliding disc. The tractor linkage is fixed at the correct height for the work operation, the lift out at the headland is carried out via the single-acting cylinder. This is in the floating position when in operation.

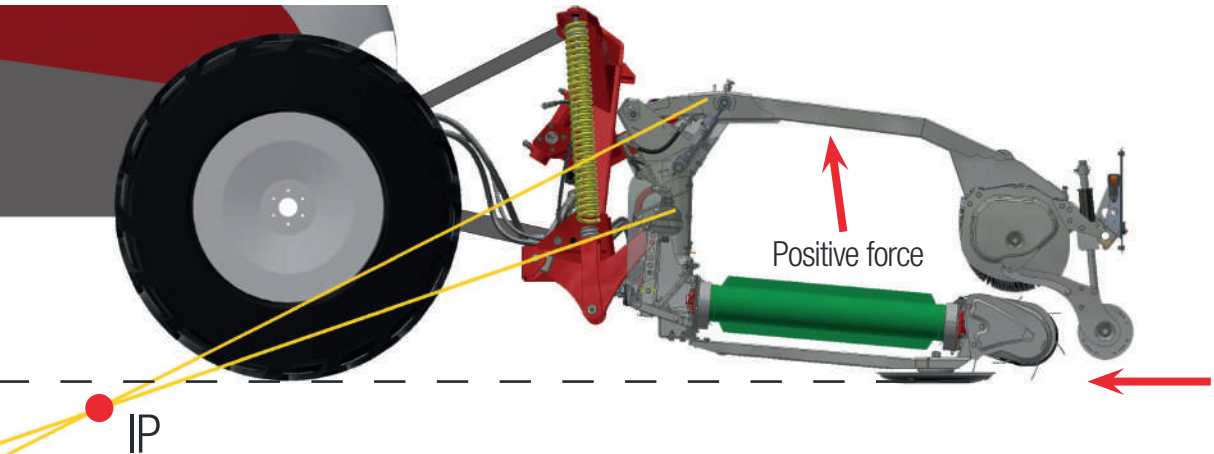

Kinematics with spring relief

RESPIRO compact & profi

# RESPIRO R3 / 3.5 PROFI

Universal in use

Perfect for tractors with  
reverse drive system

The **profi** mounting also enables use on the rear linkage of tractors with reverse drive equipment - ground hugging independent of the tractor hydraulics. Highest agility and in addition best view of the working unit.



Lowering boundary chains  
for straw windrowing

For use in **straw**, the working unit can be locked via lowering chains and so be carried over ground. No constant contact with the ground, less dust formation, stones remain on the ground, less wear on the sliding discs (low heating, no flying sparks) and on the tines.

**Swath cloth option-  
ally available**  
(all models)



# Simple operating concept

## Simple & practical

The pick-up, rotor and belt are driven via 1 single-acting hydraulic connection with pressureless return. The pick-up and rotor speed is adjusted via the oil flow rate. The required oil delivery rate is achieved even at low engine speeds, so that the tractor runs in the optimum speed range, efficiently and fuel-saving.

An additional single-acting tractor control unit is required for the lifting from the conveyor rotor. On the **RESPIRO R3 / 3.5 compact**, lifting at the headland is done via the tractor's front linkage. On the **RESPIRO R3 / 3.5 profi**, the single-acting control unit is also used by the rotor lift.



# Terminal functions

## Left ratchet switch, 3 functions

- ▶ Lock rotor (road transport)
- ▶ Rotor lift out (straw swath)
- ▶ Rotor floating position (work in the field)

**R3/3.5 profi:** machine lifting possible in position:

“Lock rotor” and “Rotor floating” position

## Central ratchet switch for deposit direction

- ▶ Belt left and right rotation
- ▶ Belt stop (collecting forage)

## Right rotary potentiometer

- ▶ Adjustment of belt speed

# DATASHEET RESPIRO R3 / 3.5

	<b>RESPIRO R3 compact 700</b>	<b>RESPIRO R3 compact 1000</b>	<b>RESPIRO R3 profi</b>	<b>RESPIRO R3.5 compact 1000</b>	<b>RESPIRO R3.5 profi</b>
<b>Rake width [m]</b>	3,00			3,50	
<b>Belt width [mm]</b>	700	1000			
<b>Transport length [m]</b>	1,79	2,10	2,40	2,10	2,40
<b>Transport width [m]</b>	2,997			3,497	
<b>Parking height [m]</b>	1,30		1,35	1,30	1,35
<b>Weight [kg]</b>	960	1080	1250	1180	1350
<b>Power requirement [hp]</b>	90	100	110		120
<b>Area output [ha/h]</b>	2-4			2-5	
<b>Required hydraulic connections</b>	2 SA + RL				
<b>Required electrical connections</b>	1x3 pin / 7 pin				

RESPIRO compact & profi

COWS WOULD BUY **RESPIRO**



Photo: Poelman Robbe

**REITER**  
www.reiter-respiro.com

**RT Engineering GmbH**  
Eben 5a, 4716 Hofkirchen a.d.T.  
Austria

Tel.: +43 7248 66717  
E-Mail: office@rt-e.at  
www.reiter-respiro.com



**RESPIRO** - Plants, animals, machines and humans respire...