



AMAZONE

Compact disc harrow ***Catros***

Compact disc harrow ***Certos***



Catros and Certos compact disc harrows

Performance: it makes sense!



In focus: more with less

- ✔ More strength
- ✔ So many possibilities of use
- ✔ More comfort and convenience
- ✔ Less fuel
- ✔ Less wearing costs
- ✔ Less maintenance costs

Compact disc harrows are ideally suited to shallow and intensively mixing soil tillage. Thanks to their extremely low pulling power requirement, combined with high forward speeds, high work rates are possible. They are also extremely economical to operate owing to their very low fuel consumption.



	Page
Catros 03	4
The right machine for every farm	6
Smart Frame System	8
Base execution Concave discs	10
X-Cutter disc	12
Face seal and individual disc suspension	14
Front tool overview	16
Crushboard	18
Knife roller	20
TS chassis TX chassis	22
Roller range	24
Rear rollers and harrows	26
Overview of the compact disc harrow range	28
Catros compact disc harrow: rigid or hydraulic-folding compact disc harrows in working widths from 2.5 m to 7 m	30
Catros compact disc harrow: trailed compact disc harrows in working widths from 7 m to 12 m	38
Certos compact disc harrow: the trailed heavy compact disc harrow with central running gear and in working widths from 5 m to 7 m	46
Equipment Overview	54
Air braking system Mounting options Additional weight Transport box	56
pro-Pack and central lubrication Slurry distributor	58
Universal conveying systems GreenDrill	60
FTender mounted front tank XTender rear tank	62
Technical data	64

**Want to learn more about operating the machine?
Click here to go to SmartLearning:**



www.amazone.net/smartlearning

Catros 03

The compact disc harrow with the Smart Frame System



The new Catros generation – for higher work rates

With the Catros 03, AMAZONE offers a perfected compact disc harrow of the latest generation. The working depth is no longer set via the rear roller on the Catros⁺ 03 but is now done by rotating the complete disc element. A fixed

linkage between the two rows of discs ensures that both rows always work at the same depth. Setting the disc stagger is a thing of the past.

- ❗ "The depth can be conveniently adjusted from the side."
- ❗ "The view into the implement is very good. The frame is of an open design."

("top agrar" – Test report · 01/2017)



The combination of look and performance of the Catros^{XL}, which was entered in the category "Farm machinery", impressed and delighted the iF jury of experts and designers from all over the world. The jury's evaluation criteria included, in addition to the quality of design, the finish and material choice, the level of innovation and the environmental compatibility, its functionality and ergonomics and, finally, a visualisation of use and safety.



Advantages of the Catros 03

- ✔ Smart Frame System
- ✔ Simple setting of the working depth by rotating the complete disc element
- ✔ Open frame design for optimum through-passage

Modular design of the compact disc harrows

- ✔ Choice of a variety of front tools
- ✔ Smooth, fine or coarse serrated discs
- ✔ Wide choice of various different rollers
- ✔ Possible combination with the GreenDrill seeder box

The right machine for every farm

Wide range of various different equipment levels for the Catros 03

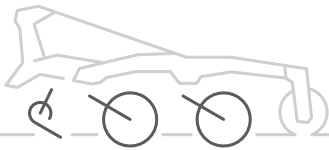

Smart Frame System

Simple, fast and precise adjustment of the working depth.

Precise stubble cultivation using the front tools for any application.

Wide range of discs for different applications.



480 mm wavy profile

Wide variety of rollers with different diameters.



SW cage roller
520 mm

SW cage roller
600 mm

WW angle profile
roller 580 mm

UW U-Profile
roller 580 mm

Optimally combined with a seeding system.



GreenDrill



Knife roller

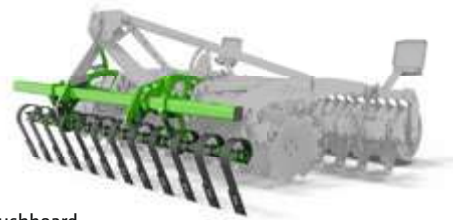

Crushboard



510 mm smooth



510 mm fine serrated



510 mm coarse serrated



610 mm coarse serrated



DW disc roller
600 mm



KW wedge
ring roller
580 mm



KWM wedge ring roller
with Matrix tyre profile
600 mm



KWM wedge ring roller
with Matrix tyre profile
650 mm



TW tandem roller
520/380 mm



DUW Double U-Profile
roller 580 mm



DDU Double-disc
U-Profile roller
600 mm



DDW Double disc
roller 600 mm

XTender



FTender



Smart Frame System for Catros 03

The Smart Frame System from AMAZONE is a completely new design of working depth adjustment for compact disc harrows. The complete row of discs is turned to adjust the working depth. The discs are either turned away from the frame to work deeper or up towards the frame to work shallower. In this respect, the main frame always remains parallel to the ground.

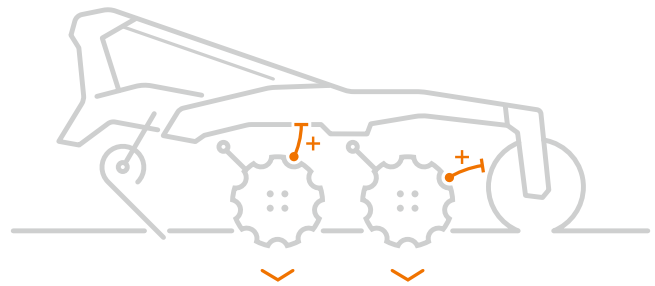
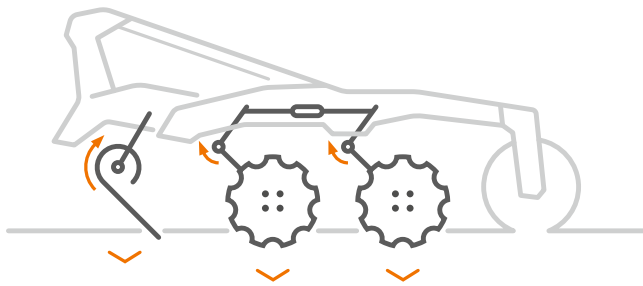

Simple and uncomplicated setting and adjustment of the working depth

- ✔ Completely independent depth adjustment of the front tools and main working section
- ✔ The first and second row of discs always work at the same depth
- ✔ Convenient for a quick change of the working depth, such as to work deeper in tramlines or on the headland

Huge through-passage, always perfectly adapted to the working depth

- ✔ The distance between the discs and the main frame automatically increases the deeper you work. When the working depth is increased, the discs are turned away from the frame and the rear roller.



Catros^{XL} 8003-2TX with knife roller





Catros^{XL} 6003-2TS at the minimum disc depth
The discs are completely swivelled in towards the frame



Catros^{XL} 6003-2TS at maximum disc depth
The discs are completely swivelled away from the frame

A top argument for the Catros 03 is the Smart Frame System with flexible working depth adjustment of the individual tools

- ✔ Independent adjustment of the front tool and the discs
- ✔ Independent adjustment of the front tool and the discs in relation to the frame

- ✔ The Smart Frame System offers maximum comfort in combination with the infinitely variable hydraulic working depth adjustment
- ✔ There is no need to leave the cab to change the working depth
- ✔ The scales display the current settings and are easily visible from the tractor seat (1)
- ✔ In addition to the independent setting of the front tools and the discs, the rear harrow settings also remain unchanged when the working depth is changed (2)

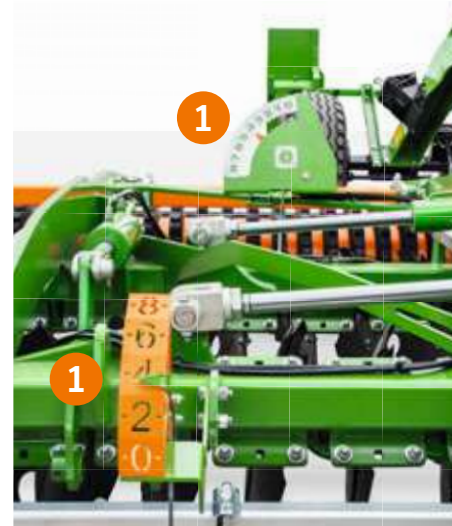

The right disc for every task!



Catros+ 510 mm
(smooth)



Catros+ 510 mm
(fine serrated)



Catros+ 510 mm
(coarse serrated)

Working depth from 5 – 14 cm



Catros^{XL} 610 mm
(coarse serrated)

Working depth from 5 – 16 cm



Certos 660 mm
(coarse serrated)

Working depth from 7 – 20 cm



Outstandingly low fuel consumption

Working speeds from 10 to 18 km/h are not a problem with the Catros and Certos compact disc harrows. This enables you to achieve incredibly high work rates and keeps the working time down to a minimum. However, the low costs for fuel, wear and tear and repair are also key factors for profitable farming.

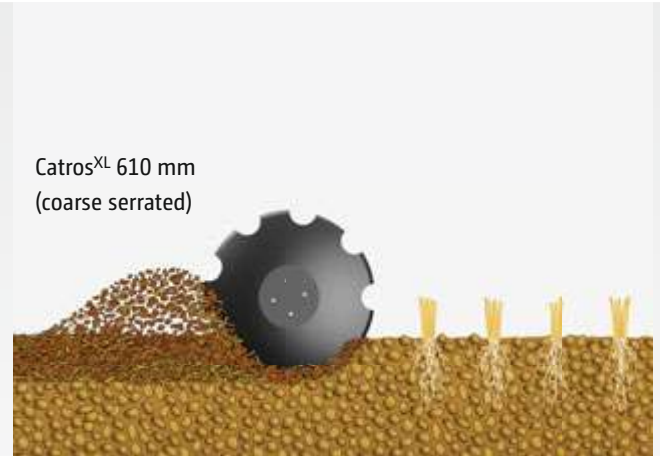
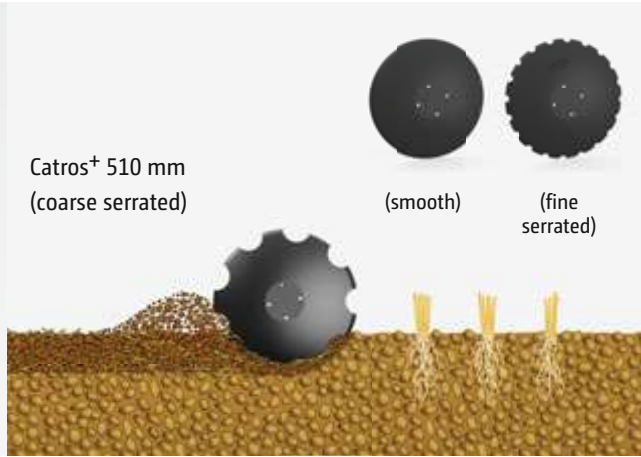

Catros⁺ discs – for a more intensive mixing

The serrated, 510 mm diameter Catros⁺ discs are characterised by their more aggressive operation and a more reliable penetration even under difficult conditions. The optimum operational range of these discs is for stubble tillage, seed-bed preparation and also the incorporation of catch crop residues.

- ✔ Working depths from 5 to 14 cm
- ✔ Thickness of discs 5 mm/Disc diameter 510 mm/Fine or coarse serrated
- ✔ Universal use for a more intensive incorporation
- ✔ More aggressive operation
- ✔ Incorporation of organic fertilisers

Catros^{XL} discs – for large amounts of organic matter

The 610 mm serrated Catros^{XL} discs allow deeper cultivation whilst still offering maximum mixing. The perfect penetration even under the most arduous conditions guarantees working depths of up to 16 cm so that a homogeneous mix is achieved.

- ✔ Working depths from 5 to 16 cm
- ✔ Thickness of disc 6 mm/Disc diameter 610 mm/Coarse serrated
- ✔ Large spacing between the second row of discs and the roller
- ✔ Optimal for incorporating catch crops and grain maize residues

Certos discs – for medium-deep soil tillage

The 660 mm diameter Certos discs are especially well suited for medium-deep and intensive soil tillage down to 20 cm. Due to the large diameter discs, the incorporation of copious amounts of maize stubble, sunflower residues, catch crops or tilling grassland is no problem. Furthermore, the Certos discs work ideally also under extreme conditions such as on hard and dry soils.

- ✔ Working depths from 7 to 20 cm
- ✔ 660 mm disc diameter/Coarse serrated
- ✔ Good penetration even on heavy soils due to a high gross weight
- ✔ Deeper, more intensive mode of operation when renovating pasture land

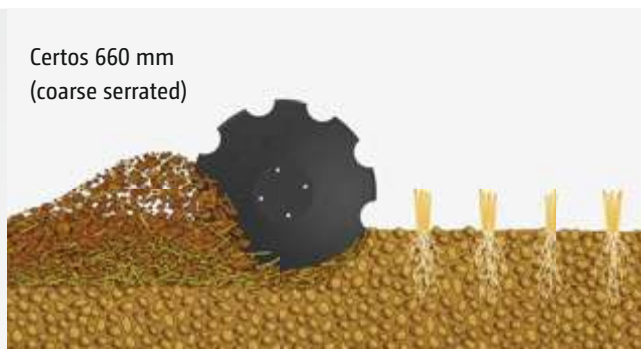

X-Cutter disc for very shallow soil tillage

Maximum shredding capacity and mixing intensity for the Catros compact disc harrow



The X-Cutter disc moves the full surface at a shallow working depth thanks to its special wavy profile

Video: Catros^{XL} 3003 with X-Cutter discs in work
www.amazone.net/yt-catrosxl3003-x-cutter-disc





X-Cutter disc with wavy profile



Catros^{XL} 3003 with X-Cutter disc, knife roller and GreenDrill

X-Cutter disc

The X-Cutter disc has a diameter of 480 mm for a high peripheral speed and performs optimally at working depths from 2 to 8 cm. Thanks to the special wavy profile, the discs maintain that full-surface cultivation across the entire working width, even at these very shallow working depths. The special disc profile produces an intensive movement of the full-surface area and is sure to impress with its high mixing intensity close to the surface that generates faster rotting. This provides optimum conditions for the following crop. The X-Cutter disc also scores with its low pulling power requirement.



Optimum shallow chopping and mixing

Very shallow tillage plays an increasingly important role when it comes to carefully managing the water balance in the soil. Shallow tillage significantly reduces the loss through evaporation of valuable soil moisture, particularly in hot and dry summers. Much less soil is moved than with other discs, which need to operate at much greater depths to move the full soil surface.

Optimally combined with the knife roller

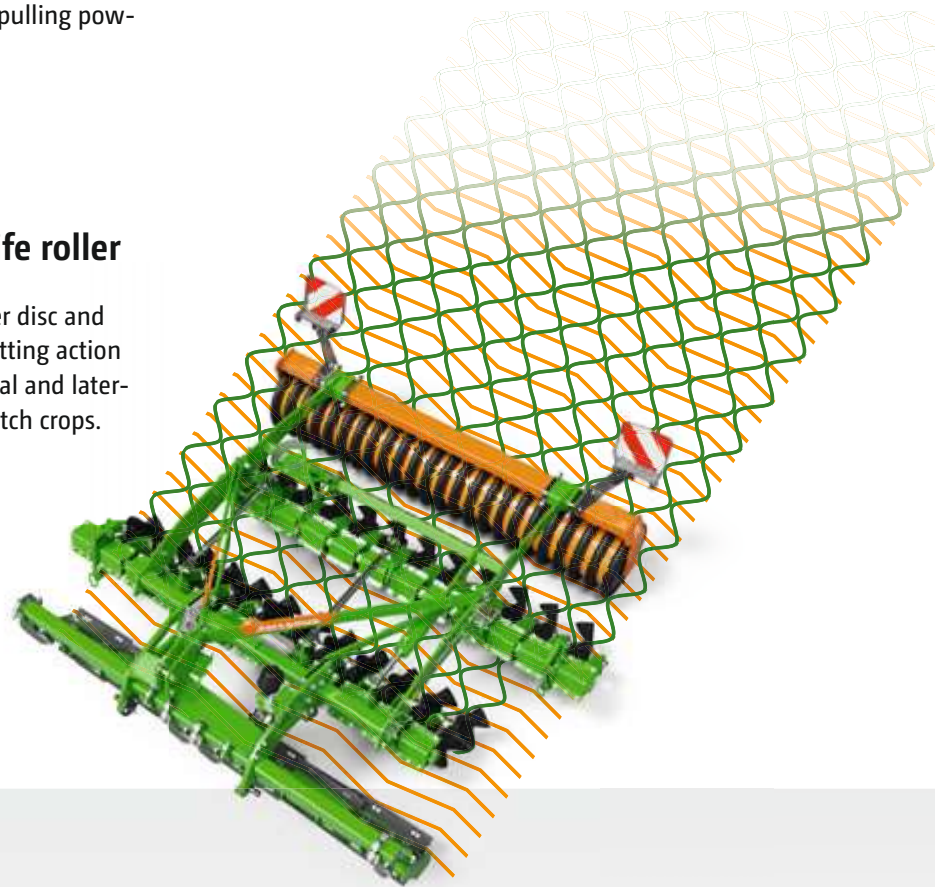
The combination of the Catros with the X-Cutter disc and the knife roller enables a multi-dimensional cutting action to take place, thereby increasing the longitudinal and lateral shredding intensity in stubbles, straw and catch crops.



-  Knife roller
-  X-Cutter disc

In conjunction with the up-front knife roller, the X-Cutter disc creates a multi-dimensional cutting action to maximise the shredding of organic matter, even where large amounts prevail

Face seal

Reliability and comfort are the key

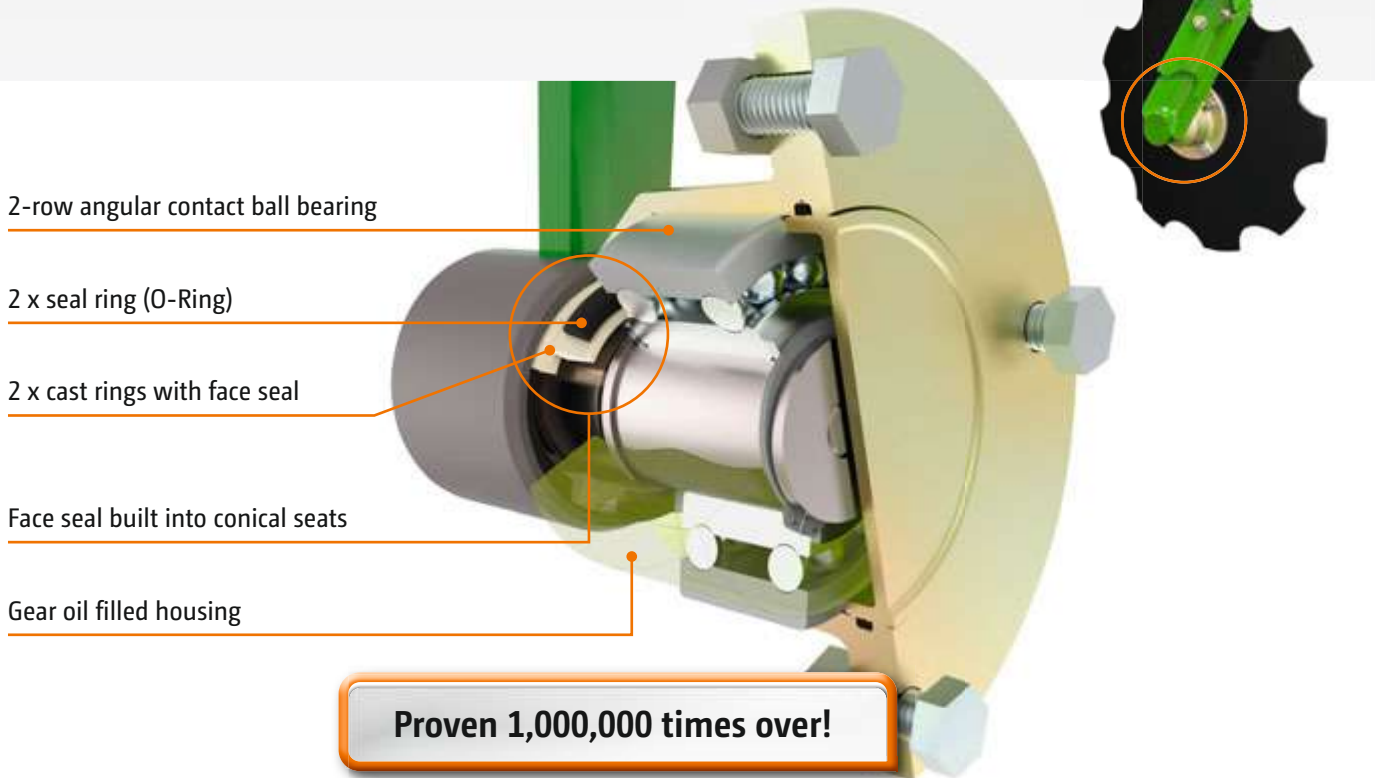

No lubrication ever again – thanks to the maintenance-free disc bearings

With no need to lubricate the disc bearings, this results in a significantly reduced overall maintenance time. Face seals have been used for decades in road construction equipment where rollers on the running gear of caterpillar-tracked

vehicles have to be effectively sealed and work with complete reliability under the toughest of operational conditions.

❗ "It is amazing that the disc bearings on the complete machine do not require any lubrication."

(Agratechnik magazine · 08/2012)

The benefits

- ✔ Maintenance-free disc bearings with face seals and life-long lubrication
- ✔ Maintenance-free overload protection via rubber spring elements
- ✔ Individual disc suspension for optimised contour following and excellent through passage

Individual disc suspension

For an optimum soil contour following

Aggressively angled discs

The Catros⁺ and Catros^{XL} discs are mounted especially aggressively with an angle of 17° for the front row of discs and 14° for the rear row of discs. This ensures a smooth transfer of the soil/organic matter mix from the first to the second row of discs and results in first-class mixing of soil and plant material. Compared with flat angled discs, the discharge angle in this aggressive disc arrangement is noticeably smaller. In this way, the moved soil/organic matter mix is redeposited on the soil surface well ahead of the rear roller.

Perfect – individually suspended discs

On all models, be it a Catros⁺, Catros^{XL} or Certos, each individual disc is suspended from the frame on elastic sprung rubber buffer blocks. This is much better than in machines with a rigid disc suspension, as each concave disc can individually follow the ground contours, meaning that wheel tracks are not simply just filled in but worked intensively. This makes for a consistent shallow tillage, even if the soil surface is uneven. At the same time, the individual suspension of the discs enables the optimum passage of large amounts of organic matter in comparison to machines where the discs are mounted in pairs, thereby increasing the through-flow.

- Utilising the slotted holes, the outer discs can be adjusted for depth to ensure a clean join up between one pass and the next.

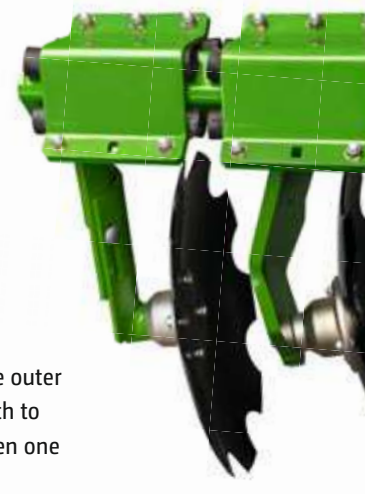

Reliable and absolutely maintenance-free!

The elastic sprung rubber buffer blocks for suspending the discs, not only ensure optimum contour following, but also act as overload safety protection on each individual disc. The large-dimensioned sprung rubber buffer blocks are maintenance-free and feature a long spring deflection that provides you with peace of mind, even in stony ground.

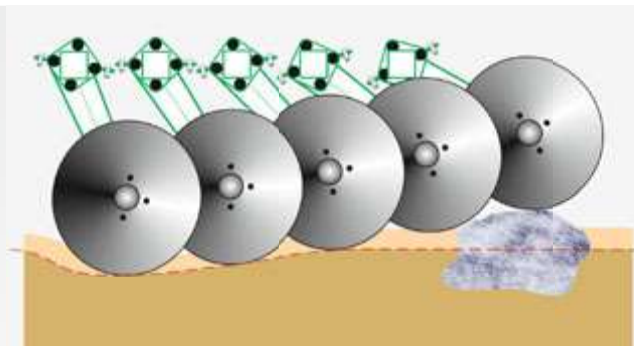

- Practically orientated down to the last detail:
Contour following of the individual disc arms including overload protection



Front tools for optimum field hygiene

The right combination for any application



Catros^{XL} with knife roller in rape stubble

The general conditions for good crop management in agriculture are continually changing owing to the increasing number of extreme weather events and stricter regulation in the use of plant protection agents. In order for crops to have the ideal start and growing conditions in their early development, better field hygiene will continue to gain in importance. Amazone therefore offers the right solution for every farm by the wide choice of front tools for the Catros compact disc harrow.



Catros^{XL} 6003-2TS with up-front knife roller



Crushboard



Knife roller

Soil-engaging options	Catros+ 3003	Catros ^{XL} 3003	Catros+ 4003-2 5003-2 6003-2 7003-2	Catros+ 4003-2TS 5003-2TS 6003-2TS 7003-2TS	Catros ^{XL} 5003-2TS 6003-2TS	Catros+ 7003-2TX 8003-2TX 9003-2TX	Catros ^{XL} 7003-2TX 8003-2TX	Catros+ 12003-2TS	Certos 5002-2TX 6002-2TX 7002-2TX
Crushboard	○	○	-	○	-	-	-	-	-
Knife roller	○	○	-	○	○	○	○	-	-
Guide wheels	-	-	-	○	○	●	●	●	●

● Standard ○ Optional



Catros^{XL} 8003-2TX with guide wheels

Crushboard

Better levelling and crumbling



Catros⁺ 3003 in operation with the Crushboard



Catros+ 3003 with Crushboard

Compact disc harrows equipped with the Crushboard are perfect for seedbed preparation, as an intensive crumbling and levelling effect is obtained. However, the Crushboard also offers certain advantages during stubble cultivation. For example, rape pods are pulverised by the Crushboard and volunteer rape is encouraged to germinate to a greater extent. Rape, sunflower and maize stubbles are also opened by the Crushboard, meaning that the subsequent straw rotting process is promoted.

The Crushboard can be adjusted irrespective of the working depth of the disc element. The working depth, and thus the aggressiveness of the Crushboard, is hydraulically adjusted from the tractor seat. The driver can easily tailor the setting to the respective conditions via the hydraulic adjustment.

Advantages of the Crushboard

- ✔ Equipped with convenient, infinitely variable hydraulic depth adjustment and an easy-to-read scale as standard
- ✔ Even better crumbling and levelling



Large clods of earth are broken up by the Crushboard in front of the disc element, thereby providing an even better quality of work

Knife roller

Shredding and incorporation of crop residues or catch crops



Catros^{XL} 6003-2TS with knife roller

❗ "The knife roller simply means that the whole plant is broken up and shredded a second time. It just looks better!"

(Bernd Stricker, farmer - 04/2021)

Catros^{XL} 8003-2TX with knife roller

The out-front knife roller on the AMAZONE compact disc harrow provides maximum flexibility for optimum soil tillage. The knife roller enables extremely shallow soil tillage with simultaneous shredding of the stubble, such as during that initial stubble cultivation after rape. However, the knife roller is also ideal for working in tall catch crops, maize or sunflower stubbles. In particular, long stubbles are cut transversely to the direction of travel and then incorporated with the subsequent disc element.

The roller is lowered into the working position from the tractor seat during work. By dividing the knife roller into segments, it means that the roller can follow the ground contours perfectly, even in uneven terrain, and can effectively shred any lying crop residues across the entire working width.

Advantages of the knife roller

- ✔ Optimum shredding results due to the high circumferential speed with a roller diameter of 330 mm
- ✔ Excellent contour following thanks to individual roller sections
- ✔ No lateral pull during work, as the blades are arranged on the roller in a V-profile
- ✔ Maintenance-free bearings with a long service life thanks to a metallic face seal
- ✔ Insensitive to stones and dirt due to the enclosed design of the roller centre shaft
- ✔ Wear costs halved thanks to reversible knives with two cutting edges, made of tempered drill steel



Advantages of the 330 mm diameter knife roller

The TS chassis

Bogey chassis for road transport



Catros⁺ 7003-2TS being used for stubble breaking

Bogey chassis – comfortable on the road!

The basic version of the Catros-2TS, having working widths from 4 to 7 m, includes the bogey chassis mounted to the rear of the machine. The weight of the chassis can be used to give better penetration on heavier soils. In addition, the TS chassis serves to provide vibration damping under extreme conditions. However, it is not required for turning at the headland. The machine can easily turn on the roller.



Product video: Catros^{XL} 03-TS
QR code to access the video



The TX chassis

The central running gear for greater working widths



Catros^{XL} 8003-2TX being used for stubble breaking

Central running gear – smooth running and easily manoeuvrable!





The base execution of the Catros-2TX trailed machines, in 7 m, 8 m and 9 m working widths, includes the central running gear. This is characterised by its smooth travel because the weight of the running gear is split evenly between the disc modules and the rear rollers. On public roads, the central transport axle with wide tyres ensures comfortable transport. Catros-2TX machines are extremely manoeuvrable due to this central running gear.



Product video: Catros⁺ 03-TX
QR code to access the video



The roller range – reconsolidation and depth control

Description, diameter																					
		SW cage roller* 520 mm				SW cage roller 600 mm				Angle profile roller *WW 580 mm				UW U-Profile roller 580 mm				DW disc roller 600 mm			
Suitability		-	o	+	++	-	o	+	++	-	o	+	++	-	o	+	++	-	o	+	++
Soil suitability	Light, sticky soils (peat)																				
	Light soils (sand)																				
	Medium soils																				
	Heavy soils																				
	Heavy soils (clay)																				
Working quality	Crumbling																				
	Reconsolidation																				
	Self-driving ability (less slip)																				
	Carrying capacity																				
	Insensitive to stones																				
	Insensitive to sticky soils																				
	Little tendency to block																				
Weight/ m working width		97 kg				114 kg				112 kg				125 kg				219 kg			
Rear harrow		optional				optional				optional				optional				optional			

Further options



- less suited
o suited

+ well suited
++ very well suited



* only available in 3 m

Roller bearings

All rear rollers on AMAZONE compact disc harrows are equipped with bolt-on bearing shafts. This keeps repair work to a minimum in the case of bearing damage. The robust spherical roller bearings provide high reliability and a long service life.



HD roller bearings

The roller bearings are now optionally available in an HD version for maximum operational reliability and an extreme service life.

- ✔ Extreme service life thanks to a metallic face seal
- ✔ Completely maintenance-free with life-long lubrication thanks to the gear oil filling
- ✔ Robust and hardwearing due to spherical roller bearings instead of ball bearings



KW wedge ring roller 580 mm	KWM wedge ring roller with Matrix tyre profile 600 mm	KWM wedge ring roller with Matrix tyre profile 650 mm	TW tandem roller 520/380 mm	DUW Double U-Profile roller 580 mm	DDU Double-disc U-Profile roller 600 mm	DDW Double disc roller 600 mm
- ○ + ++	- ○ + ++	- ○ + ++	- ○ + ++	- ○ + ++	- ○ + ++	- ○ + ++
175 kg	178 kg	205 kg	160 kg	185 kg	255 kg	270 kg
optional	optional	optional	-	optional	-	-



* only available in 3 m

Combination of rear roller and harrow



The perfect supplement to seedbed preparation

For seedbed preparation ahead of maize or sugar beet, the AMAZONE compact disc harrows can be equipped with a following harrow as an addition to a wide variety of rollers. The following harrow creates a very fine-crumbled soil

surface structure and thus the perfect germination conditions for the following crops. An additional advantage when using the harrow is the optimised straw distribution.



Harrow system for SW, PW, KW & UW rear rollers



Sprung knife system* for WW rear rollers



Harrow system for KWM & DW rear rollers



Sprung clearing system for UW rear rollers



Harrow system for TW & DUW following rollers

* Please note! Turning on the rear roller is not possible in conjunction with TS running gear.

! "The wide variety of equipment options – which also include eleven roller types – offer potential well beyond just stubble cultivating."

("profi" – Test report on the Catros^{XL} 3003 · 07/2021)

Overview of Catros and Certos compact disc harrows

 Catros⁺ 3003

 Catros⁺ 5003-2

 Catros⁺ 7003-2TS with bogey chassis

Catros mounted and trailed compact disc harrows
 working width 2.5 m to 7 m

Model		see Page 30			
		Catros ⁺ 2503 3003 3503 4003	Catros ^{XL} 3003 3503 4003	Catros ⁺ 4003-2 5003-2 6003-2 7003-2	Catros ⁺ 4003-2TS 5003-2TS 6003-2TS 7003-2TS
Working width (m)	2.50	●	–	–	–
	3.00	●	●	–	–
	3.50	●	●	–	–
	4.00	●	●	●	●
	5.00	–	–	●	●
	6.00	–	–	●	●
	7.00	–	–	●	●
	8.00	–	–	–	–
	9.00	–	–	–	–
	12.00	–	–	–	–
Disc diameter (mm)	480	–	●	●	●
	510	●	–	●	●
	610	–	●	–	–
	660	–	–	–	–
Frame execution		rigid		folding	

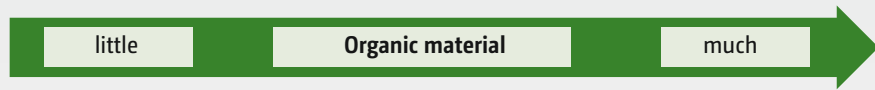

X-Cutter
Ø 480 mm



Catros+
Ø 510 mm



Catros^{XL}
Ø 610 mm



Certos
Ø 660 mm



Catros+ 7003-2TX with central running gear



Catros+ 12003-2TS with bogey chassis



Certos 6002-2TX with central running gear



Catros trailed compact disc harrows
working width 7 m to 12 m

Certos heavy trailed compact disc harrow
Working width 5 m to 7 m

see Page 38				see Page 46
Catros ^{XL} 5003-2TS 6003-2TS	Catros+ 7003-2TX 8003-2TX 9003-2TX	Catros ^{XL} 7003-2TX 8003-2TX	Catros+ 12003-2TS	Certos 5002-2TX 6002-2TX 7002-2TX
-	-	-	-	-
-	-	-	-	-
-	-	-	-	-
-	-	-	-	-
●	-	-	-	●
●	-	-	-	●
-	●	●	-	●
-	●	●	-	-
-	●	-	-	-
-	-	-	●	-
-	●	-	-	-
-	●	-	●	-
●	-	●	-	-
-	-	-	-	●
folding				folding

Catros compact disc harrows

As a mounted compact disc harrow, or trailed compact disc harrow with TS bogey chassis

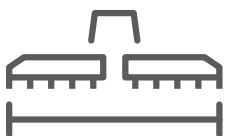

2.5 to 7 m



2 to 16 cm



up to 18 km/h

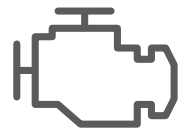

from 75 hp

The advantages at a glance:

- + Easy to pull, from 2.5 m working width with a tractor power requirement from just 75 hp
- + Central and simple mechanical working depth adjustment on the left-hand side of the machine
- + Working depth adjustment via the Smart Frame System including a scale for reading off the working depth
- + Maintenance-free disc bearings with face seals and life-long lubrication
- + Maintenance-free stone safety protection via rubber sprung buffer blocks
- + Standard with individual disc suspension for optimised contour following and excellent through passage
- + Folding and adjustable side discs for a perfect matching up bout to bout
- + The GreenDrill seeder box can be specified as an option

MORE INFORMATION

<https://amazone.net/compact-disc-harrows>



PRODUCT FILM
Find out more



SMARTLEARNING
www.amazone.net/smartlearning

Catros⁺ 03

Mounted compact disc harrow with a wide variety of specification options



Catros⁺ 510 mm (smooth)

Catros⁺ 510 mm (fine serrated)

Catros⁺ 510 mm (coarse serrated)



Catros⁺ 3003

The Catros⁺ 03 mounted compact disc harrow is ideal for fast, shallow and intensively mixing soil tillage. This extremely simple and keenly priced mounted compact disc harrow, with working depths from 2 to 14 cm, is the ideal entry-level model for small to medium-sized farms.

Model	Working width
Catros ⁺ 2503	2.5 m
Catros ⁺ 3003	3.0 m
Catros ⁺ 3503	3.5 m
Catros ⁺ 4003	4.0 m



2.5 to 4 m



2 to 14 cm



up to 18 km/h

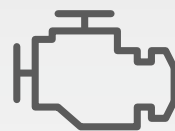

from 75 hp

Catros^{XL} 03

XL performance when working in catch crops



X-Cutter disc with wavy profile 480 mm



Catros^{XL} 610 mm (coarse serrated)



Catros^{XL} 3003

AMAZONE offers a rigid compact disc harrow in working widths of up to 4 m and mounted on the 3-point linkage in the shape of the Catros^{XL} 03. The machine is ideally suited for farms with a high level of harvest residues and heavy soils where deeper working depths are required in order to incorporate the organic matter.

Model	Working width
Catros ^{XL} 3003	3.0 m
Catros ^{XL} 3503	3.5 m
Catros ^{XL} 4003	4.0 m



3 to 4 m



5 to 16 cm



up to 18 km/h



From 120 hp

Catros⁺ 03-2

Folding compact disc harrow for shallow soil tillage



Catros⁺ 5003-2 in stubble tillage



X-Cutter disc with wavy profile 480 mm Catros+ 510 mm (smooth) Catros+ 510 mm (fine serrated) Catros+ 510 mm (coarse serrated)



Catros+ 5003-2

The folding mounted compact disc harrow Catros+ 03-2 demonstrates its capability in shallow stubble cultivation. The 510 mm discs penetrate well into the soil and ensure a shallow and intensively mixed soil tillage. The X-Cutter, also available from AMAZONE, offers a special disc for very shallow soil tillage from 2 to 8 cm. The use of front tools is not possible with the mounted, folding models.

Model	Working width
Catros+ 4003-2	4.0 m
Catros+ 5003-2	5.0 m
Catros+ 6003-2	6.0 m
Catros+ 7003-2	7.0 m



4 to 7 m



2 to 14 cm



up to 18 km/h

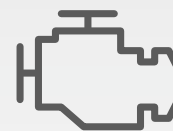

from 125 hp

Catros⁺ 03-2TS

The trailed compact disc harrow with bogey chassis



X-Cutter disc with wavy profile 480 mm Catros⁺ 510 mm (smooth) Catros⁺ 510 mm (fine serrated) Catros⁺ 510 mm (coarse serrated)



Catros⁺ 7003-2TS

The folding mounted compact disc harrow Catros⁺ 03-2TS demonstrates its capability in shallow stubble cultivation. The 510 mm discs penetrate well into the soil and ensure a shallow and intensively mixed soil tillage. The X-Cutter, also available from AMAZONE, offers a special disc for very shallow soil tillage from 2 to 8 cm. The Catros can be combined with various different front tools on account of the bogey chassis.

Model	Working width
Catros ⁺ 4003-2TS	4.0 m
Catros ⁺ 5003-2TS	5.0 m
Catros ⁺ 6003-2TS	6.0 m
Catros ⁺ 7003-2TS	7.0 m

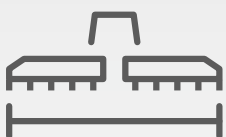

4 to 7 m



2 to 14 cm



up to 18 km/h



from 125 hp



Catros^{XL} 610 mm
(coarse serrated)

Catros^{XL} 03-2TS

The trailed compact disc harrow with bogey chassis and XL variant



Catros^{XL} 6003-2TS

With the Catros^{XL} 03-2TS, it means that there is a model in the trailed compact disc harrow segment with bogey chassis that is also available as an XL variant with 610 mm discs for a working depth of up to 16 cm. Owing to the large distances between the two rows of discs and the roller, the machine provides a high level of passage for organic matter. The additional weight of the machine means it penetrates very well into dry soils.

Model	Working width
Catros ^{XL} 5003-2TS	5.0 m
Catros ^{XL} 6003-2TS	6.0 m

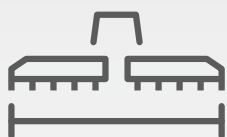

5 to 6 m



5 to 16 cm



up to 18 km/h

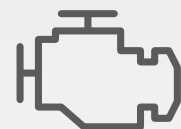

from 160 hp

Trailed compact disc harrows

The Catros-2TX and Catros 12003-2TS – the professional's choice

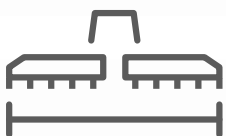

7 to 12 m



2 to 16 cm



up to 18 km/h

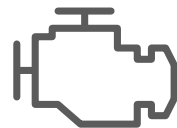

from 210 hp

The advantages at a glance:

- + Easy to pull, from 7 m working width with a tractor power requirement from 210 hp
- + The TX central running gear provides the machine with high manoeuvrability and comfort during road transport
- + Comfortable hydraulic working depth adjustment via the Smart Frame System including a scale for reading the working depth
- + ContourFrame for optimum ground contour following of each individual section
- + Maintenance-free disc bearings with face seals and life-long lubrication
- + Maintenance-free stone safety protection via rubber sprung buffer blocks
- + Individual disc suspension for optimised contour following and excellent through passage
- + The GreenDrill seeder box can be specified as an option

MORE INFORMATION

<https://amazone.net/compact-disc-harrows>



PRODUCT FILM
Find out more



SMARTLEARNING
www.amazone.net/smartlearning

Catros⁺ 03-2TX

The professional machine for maximum work rates



X-Cutter disc with wavy profile 480 mm



Catros⁺ 510 mm (smooth)



Catros⁺ 510 mm (fine serrated)



Catros⁺ 510 mm (coarse serrated)



Catros⁺ 8003-2TS in stubble cultivation

The Catros⁺-2TX trailed compact disc harrow is ideal for shallow and intensively mixing soil tillage. The central running gear provides the machine with excellent manoeuvrability, thereby allowing safe and fast road travel, despite working widths of 7 to 9 m. The extremely smooth running and low pulling power requirement ensure maximum driving comfort with maximum performance and working depths of 2 to 14 cm.

Model	Working width
Catros ⁺ 7003-2TX	7.0 m
Catros ⁺ 8003-2TX	8.0 m
Catros ⁺ 9003-2TX	9.0 m



7 to 9 m



2 to 14 cm



up to 18 km/h

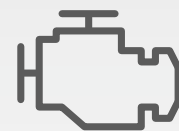

from 210 hp



Catros^{XL} 610 mm
(coarse serrated)

Catros^{XL} 03-2TX

XL efficiency brought to stubble tillage



Catros^{XL} 8003-2TX stubble cultivating with a top-mounted GreenDrill for catch crop sowing

With the Catros^{XL} 03-2TX, it means that a model in the trailed compact disc harrow segment with central running gear is also available as an XL variant with a working depth of up to 16 cm. Due to the large 610 mm discs and the large distances between the rows of discs and between the last row of discs and the roller, the XL variant of the Catros 03-2TX is characterised above all by its ability to handle a high level of organic matter. In addition, the machine demonstrates its capability on heavy soils.

Model	Working width
Catros ^{XL} 7003-2TX	7.0 m
Catros ^{XL} 8003-2TX	8.0 m

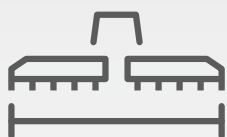

7 to 8 m



5 to 16 cm



up to 18 km/h

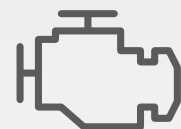

from 280 hp

Pure efficiency – the Catros⁺ 12003-2TS



Catros⁺ 510 mm
(smooth)



Catros⁺ 510 mm
(fine serrated)



Catros⁺ 510 mm
(coarse serrated)

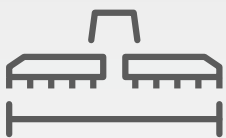

12 m



2 to 14 cm



up to 18 km/h

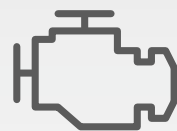

from 360 hp



! "Three metres wide, less than four metres high and approved for 40 km/h: hence the high turn round times, even during transport."*
 ("profi" – driving report for AMAZONE Catros+ 12003-2TS · 12/2015)

*Please observe country-specific traffic regulations!

More output! The flagship in 12 m

The Catros+ 12003-2TS trailed compact disc harrow is ideal for shallow and intensively mixing soil tillage at working depths of 2 to 14 cm. Thanks to its extremely low pulling power requirement despite its 12 m working width, extremely high speeds combined with high acreage outputs are possible. It is also extremely economical to operate owing to its low fuel consumption.

Easy adjustment

The working depth is quickly and easily adjusted at just one point per disc segment. Each section is equipped with a hydraulic cylinder where the range of travel of the piston rod is limited by swivelling spacers in and out. Here, the front and the rear disc rows adjust themselves automatically. In addition, in-cab hydraulic working depth adjustment is also available.

The working width can also be temporarily reduced to 7 m to improve penetration in very hard soils e.g. on the headland.



Reduction of the working width to 7 m

High performance even during transport

The machine is characterised by a compact design despite the large working width of 12 m. The Catros+ 12003-2TS is folded down to a transport width of 3 m with a transport height of 4 m for road transport.

With more comfort!

The integrated swing compensation on the drawbar of the Catros+ 12003-2TS is extremely practical. If necessary, it can be switched on to effectively reduce any pitching or bouncing of the machine. The oversized 700/50-26.5 running gear wheels provide an excellent handling behaviour of the machine on the road. For maximum comfort, AMAZONE offers an electrically-operated central lubrication system as an option.

Model	Working width
Catros+ 12003-2TS	12.0 m

! "With the new Catros+ 12003-2TS, AMAZONE can get the best output from its discs."
 ("profi" – driving report for AMAZONE Catros+ 12003-2TS · 12/2015)

Product video: Catros+ 12003-2TS QR code to access the video



ContourFrame

For Catros⁺-2TX and Catros⁺ 12003-2TS



Catros⁺ 8003-2TX with wedge ring roller with Matrix tyre profile in 8 m working width

❗ "Also simple, above all, is the adjustment of the machine."
("profi" – driving report for AMAZONE Catros⁺ 12003-2TS · 12/2015)

❗ "A positive impression, in addition to the good handling, it gives, above all, an excellent ground contour following."
("profi" – driving report for AMAZONE Catros⁺ 12003-2TS · 12/2015)

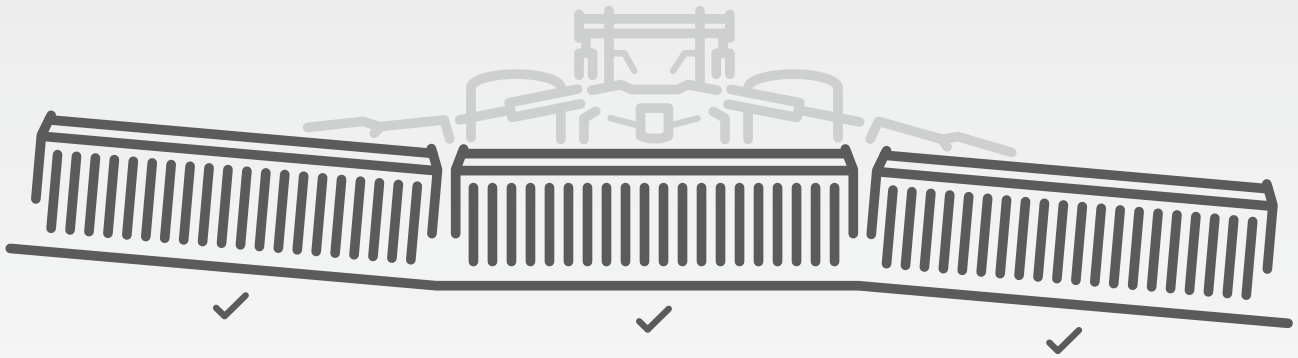

Thanks to the ContourFrame, the compact disc harrow is also suitable for use on hilly terrain

Optimum ground contour following

The Catros⁺-2TX and Catros⁺ 12003-2TS trailed compact disc harrows are divided into distinct sections, so that each of these sections guarantees a consistent working depth and also ensures the same depth when working on slopes or in hollows. Each of the Catros⁺-2TX models features twin outer sections and a centre section. The Catros⁺ 12003-2TS is made up of outer and inner sections. The segment depth is controlled via the rear roller behind. The outer segments at the front of the Catros⁺-2TX are supported via the support wheels and the middle segment via the drawbar. The front of each segment in the Catros⁺ 12003-2TS is carried by a support wheel.

The short distance between the support wheels and the roller provides excellent contour following over hills and through hollows.

Perfect working performance

As the full weight of the centre running gear of the Catros⁺-2TX and that of the rear running gear of the Catros⁺-2TS acts on the discs during operation, good penetration of the discs is ensured, even under tough conditions.

Smooth, even ride

The wing sections are hydraulically pre-pressurised via hydraulic accumulators during operation. The hydraulic pre-pressurisation allows individual ground contour following on any of the sections, both upwards and downwards. In this way, the complete machine frame optimally follows the ground contours and provides an even working profile over the entire working width. Thanks to the individual contour following, a smooth ride is possible even under difficult operational conditions and thus an even quality of work is guaranteed.

❗ "The outer wings follow the ground contours better with ContourFrame."

("agrarheute" – driving report for AMAZONE Catros^{XL} 8003-2TX · 03/2021)

Advantages of ContourFrame

- ✔ Even working profile thanks to individual ground contour following of the sections, both upwards and downwards
- ✔ Good penetration even under tough conditions due to the weight of the chassis on the discs
- ✔ The Catros-2TX trailed compact disc harrows are also available without ContourFrame as an option



Certos-2TX heavy trailed compact disc harrow

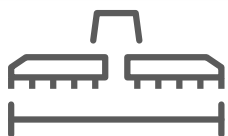

5 to 7 m



7 to 20 cm



up to 15 km/h

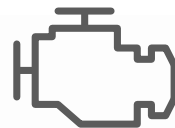

from 200 hp

The advantages at a glance:

- ⊕ Maintenance-free disc bearings with face seals and life-long lubrication
- ⊕ Maintenance-free stone safety protection via rubber sprung buffer blocks
- ⊕ Individual disc suspension for optimised contour following and excellent through passage
- ⊕ The hydraulic top tie bar counteracts any side forces and makes operation possible on slopes
- ⊕ Intensive mixing, incorporation and a high through passage capacity for handling large amounts of plant residues
- ⊕ The central running gear provides the machine with a high manoeuvrability and output
- ⊕ The large spacing between discs and following roller gives the optimum mixing
- ⊕ Hydraulic working depth adjustment with a readily-visible scale showing the working depth
- ⊕ Optional Crushboard behind the disc modules for seedbed preparation are possible

MORE INFORMATION

<https://amazone.net/compact-disc-harrows>



PRODUCT FILM
Find out more



SMARTLEARNING
www.amazone.net/smartlearning



Certos 660 mm
(coarse serrated)

Certos 02-2TX

Heavy compact disc harrows from 5 m to 7 m



Perfect levelling between passes



Certos 6002-2TX

The powerful all-rounder

The Certos-2TX heavy trailed compact disc harrow is ideal for intensively mixing soil tillage and medium-deep soil tillage. With its 660 mm discs, the Certos-2TX penetrates the soil down to 20 cm and incorporates also large amounts of organic matter, blockage-free. Thanks to its wide application range, the Certos-2TX, in working widths of 5 m to 7 m, is the powerful all-rounder for any farm.

Model	Working width
Certos 5002-2TX	5.0 m
Certos 6002-2TX	6.0 m
Certos 7002-2TX	7.0 m

For medium-deep soil tillage

The 660 mm diameter Certos discs are especially well suited for medium-deep and intensive soil tillage down to 20 cm. Due to the large diameter discs, the incorporation of copious amounts of maize stubble, sunflower residues, catch crops or tilling grassland is no problem. Furthermore, the Certos discs work ideally also under extreme conditions such as on hard and dry soils.

- ✔ Working depths of 7 cm to 20 cm
- ✔ Thickness of disc 6 mm/Disc diameter 660 mm/Coarse serrated
- ✔ Good penetration even on heavy soils due to a high gross weight
- ✔ Deeper, more intensive mode of operation when renovating pasture land

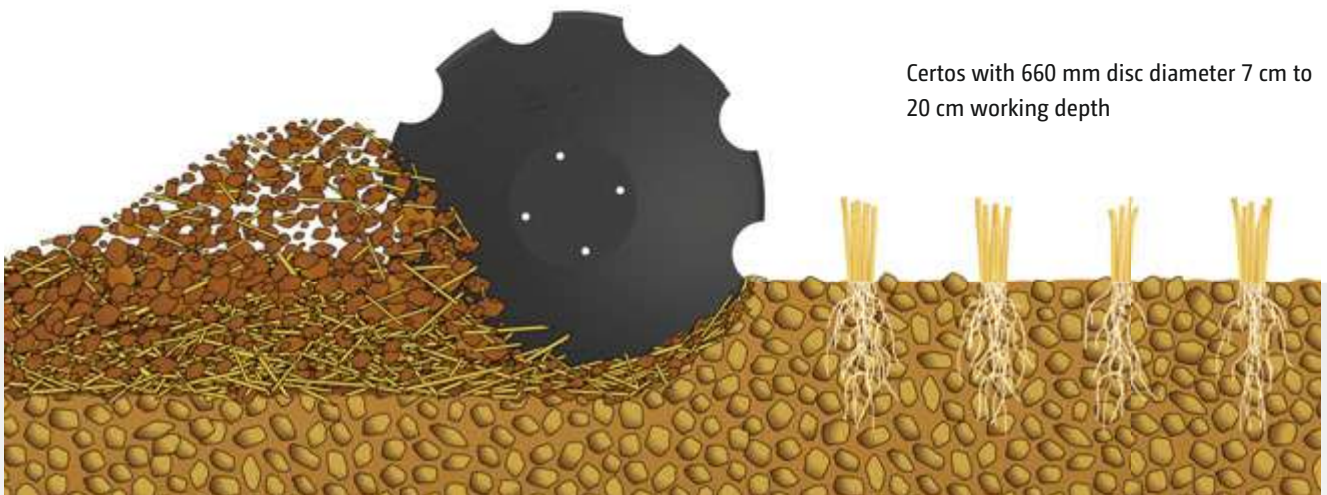

Certos with 660 mm disc diameter 7 cm to 20 cm working depth

Certos – the powerful heavyweight with maximum output



Certos 6002-2TX

Individual disc suspension

For an optimum soil contour following

Perfect working results

The disc diameter on compact disc harrows has a significant impact on the working depth and the quality of work. The very large 660 mm diameter serrated discs of the Certos-2TX are set at a very aggressive angle of 22° in the front row, which not only results in an excellent working profile, even on heavy soils, but also in an increased undercut. Furthermore, the soil is loosened perfectly and an even working profile is created in between passes as well.



- ✔ Adjustable side discs enable clean matching under any conditions

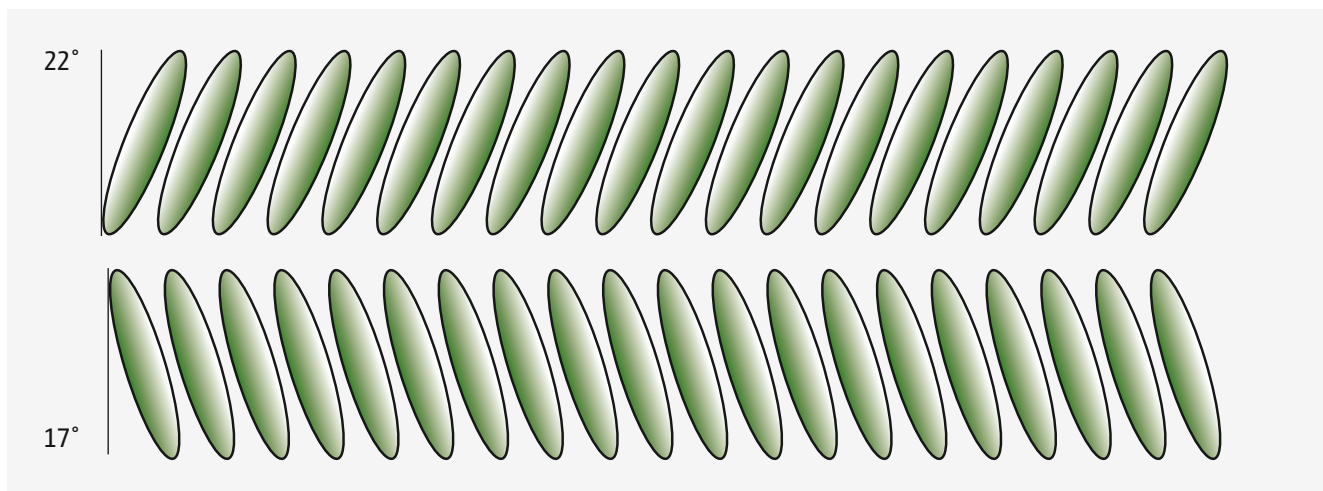

- ✔ An even working depth and an excellent working result are achieved thanks to the V-shaped disc arrangement

Whether shallow or deep – always fast and intensive



40 km/h



Pure output, even on the road!

Equipped with air braking as standard, the Certos 02-2TX can be transported quickly on the road with a permissible speed of 40 km/h. Please observe the national traffic regulations!

- ❗ "The whole job with the Certos is easily done, not least because the running gear is positioned between the disc rows and the roller which very much benefits the manoeuvrability."
("profi" Practice report for AMAZONE Certos 4001-2TX · 07/2017)



Drawbar damping system as standard

Central running gear

The integrated central running gear, equipped with 700/40-22.5, 550/45-22.5 or 400/60-22.5 tyres, ensures excellent manoeuvrability of the machine, both in the field and on the public road. The position of the running gear guarantees good weight distribution and allows the use of all AMAZONE rear rollers – this means the most suitable roller depending on the soil conditions can be utilised. To avoid any rocking of the machine, the Certos-2TX is equipped as standard with a drawbar shock absorbance system whereby the pressure is matched according to the prevailing situation.

Hydraulic top tie bar – always on an even keel

The Certos is equipped with an additional hydraulic top tie bar, in order to be able to compensate for the sideways pulling of the machine. The additional cylinder at the rear of the machine allows the simple and very sensitive correction of the machine. Via a double-acting spool valve, the machine can be set to optimally match up from the tractor cab. Especially for when working on slopes, the top tie bar is of huge benefit.



Hydraulic top tie bar on Certos 6002-2TX

Hydraulic working depth adjustment

The Certos-2TX is equipped with hydraulic working depth adjustment as standard. This offers a high degree of comfort as it allows the working depth to be adjusted from the tractor cab, even on the move.

Advantages of the hydraulic working depth adjustment

- ✔ Soil tillage only as deep as necessary thanks to infinitely variable adjustment from the tractor cab
- ✔ Flexible and quick adaptation to the operating conditions (headland, wheel tracks, ...)
- ✔ Clearly visible scale for orientation



- ✔ Hydraulic working depth adjustment is fitted as standard



- ✔ Manual working depth adjustment, in which spacers are used to adjust the depth, is available as an option

Equipment overview for Catros / Certos

 Catros⁺ 3003

 Catros⁺ 5003-2

 Catros⁺ 7003-2TS with
bogey chassis

Catros mounted and trailed compact disc harrows
working width 2.5 m to 6 m

Model		Page	Catros mounted and trailed compact disc harrows working width 2.5 m to 6 m			
			Catros ⁺ 2503 3003 3503 4003	Catros ^{XL} 3003 3503 4003	Catros ⁺ 4003-2 5003-2 6003-2 7003-2	Catros ⁺ 4003-2TS 5003-2TS 6003-2TS 7003-2TS
Linkage systems	Cat. 2	57	●	–	–	–
	Cat. 3	57	●	●	●	●
	Cat. 3-N	57	●	●	–	–
	Cat. 4-N	57	–	–	●	●
	K80	57	–	–	–	●
	Towing eye	57	–	–	–	●
pro-Pack	58	–	–	●	–	
Electrically-operated central lubrication system	59	–	–	●	●	
GreenDrill seeder box for fine seeds and catch crops	GD 200	61	●	●	●	–
	GD 501	61	–	–	–	●
FTender mounted front hopper	62	–	–	–	●	
XTender rear hopper	62	–	–	–	●	
Frame execution			rigid		folding	



GreenDrill seeder box



FTender mounted front hopper 1600



XTender rear hopper 4200

Catros+ 7003-2TX with central running gear



Catros+ 12003-2TS with bogey chassis



Certos 6002-2TX with central running gear



Catros trailed compact disc harrows
working width 7 m to 12 m

Certos heavy trailed compact disc harrows
Working width 5 m to 7 m

Catros ^{XL} 5003-2TS 6003-2TS	Catros ⁺ 7003-2TX 8003-2TX 9003-2TX	Catros ^{XL} 7003-2TX 8003-2TX	Catros ⁺ 12003-2TS	Certos 5002-2TX 6002-2TX 7002-2TX
-	-	-	-	-
●	●	●	●	●
-	-	-	-	-
●	●	●	●	●
●	●	●	●	●
●	●	●	●	●
-	●	-	-	-
●	●	●	●	-
-	-	-	-	-
●	●	●	-	-
●	●	●	-	-
●	●	●	-	-
folding				folding

Perfect equipment options



- ❗ "Attachment via the lower links ensures good manoeuvrability on the headland".

("agrarheute" – driving report for AMAZONE Catros^{XL} 8003-2TX · 03/2021)



Linkage systems for every tractor

Comprehensive and suitable mounting and drawbar possibilities are available for all compact disc harrows and any kind of tractor. The flange plate allows the easy and quick mounting of any of the linkage options. In addition, the category of the lower linkage can be quickly changed. Only

the linkage pins are interchanged for this purpose. As a result, the right linkage can be selected for any tractor, no matter whether it is Cat. II, III, III-N, IV, IV-N lower or one of various towing eye sizes or the K80 ball coupling.

For the most arduous of applications

In order to increase the penetration into the soil on dry, hard soils, additional ballast weight are available as a special option. An additional weight set consists of four 25 kg slices. The maximum additional weight for rigid machines is 200 kg. Up to 400 kg is possible for folding 3-point mounted machines and the Catros-2TS models (4 m to 7 m working width).

Toolbox

The optional toolbox for the Catros⁺-2TS and Catros⁺-2TX can be fitted to the drawbar and offers additional valuable storage space.



pro-Pack and central lubrication

Prepared for any challenge



Catros⁺ 7003- 2 with pro-Pack and harrow

pro-Pack for intensive slurry application

With the pro-Pack, Amazone offers a special equipment option for when mounted directly on, or attached to, a slurry tanker. The pro-Pack provides specific solutions to improve the reliability and durability of machines which are constantly working with slurry, e.g. behind a self-propelled slurry tanker.

Advantages of the pro-Pack

- Additionally protected and lubricated components and bearings ensure functionality and operational reliability even under the toughest of conditions

Model	Working width
Catros ⁺ 5003-2 pro	5.0 m
Catros ⁺ 6003-2 pro	6.0 m
Catros ⁺ 7003-2 pro	7.0 m
Catros ⁺ 7003-2TX pro	7.0 m
Catros ⁺ 8003-2TX pro	8.0 m
Catros ⁺ 9003-2TX pro	9.0 m



Slurry application after the first disc



Slurry application before the first disc



SynCult slurry distributor

SynCult slurry distributor

The SynCult slurry distributor has been developed in combination with Vogelsang. Using a galvanised adapter frame, the distributor and the pipe routing for the liquid manure system are rigidly mounted above the first disc row on the Catros. The liquid manure is delivered to the cultivated surface left by the discs via the front disc row. The organic fertiliser is well mixed in and covered with soil by the following second disc row.



SW 600 pro cage roller

SW 600 pro cage roller

AMAZONE offers a roller which has been specially tailored for slurry spreading in the shape of the SW 600 pro cage roller. However, all the other rollers can also be used.

Double harrow

The machines in 6 m and 7 m working widths can also be equipped with a double harrow. This provides faster drying and warming of the soil. At the same time, the double harrow reduces the weight of the machine.

Electrically-operated central lubrication system

An electrically-operated central lubrication system is available for maximum comfort. This supplies all the lubrication points automatically. In this way the maintenance can be significantly reduced and the reliability yet further improved.

Advantages of the electrically-operated central lubrication system

- ✔ Maximum comfort thanks to a significant reduction in maintenance
- ✔ Longer machine life

Pump with reservoir



❗ "We opted for the Catros with pro-Pack because it is currently the strongest and most robust machine on the market and our customers are very satisfied!"

(Michael Hesselbach, agricultural contractor · 04/2021)

Universal conveying systems for Catros – the choice is yours!

Combine the Catros with an optimum seeding system ...

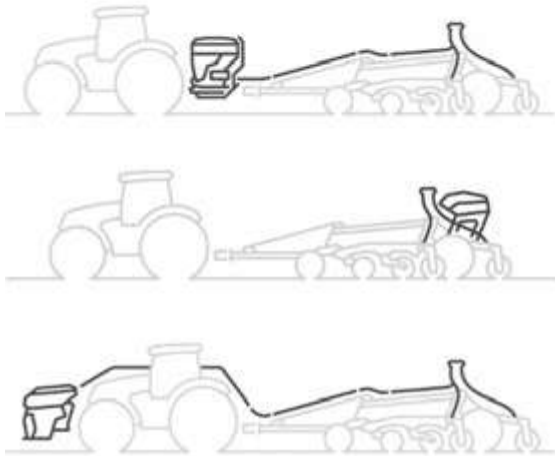

Advantages of conveying systems with a segmented distributor head

- ✔ Optimum lateral distribution across the entire working width
- ✔ Combination of different sowing systems
- ✔ High application rates possible
- ✔ Has the option to be equipped with 12 to 48 outlets
- ✔ Part-area, site-specific sowing



Convenient operation via the ISOBUS terminal



Easy exchange of the metering rollers

... it makes no difference whether it's the GreenDrill, XTender or FTender

The universal conveying system enables the Catros to be combined with different sowing systems. For example, the GreenDrill 501, with its 500 l hopper capacity, can be used in exactly the same way as the front or rear hoppers with their respective capacities of 1,600 to 4,200 l. In addition to catch crops, other seeds or even mineral fertilisers such as micro-granules can be applied.

Model	Hopper capacity (l)
Catch crop seeder box	
GreenDrill 200	200
GreenDrill 501	500
Mounted front hopper	
FTender 1600	1,600
FTender 2200	2,200
Rear hopper	
XTender 4200	4,200
XTender-T 4200	4,200



High flexibility provided by the segmented distributor head

GreenDrill

Universal catch crop seeder box for fine seed and catch crops

Catch crop sowing and soil tillage in one operational pass

AMAZONE offers the GreenDrill 200 Pack top seed drills for the mounted models and the GreenDrill 501 for the trailed machines that enable the direct establishment of catch crops in combination with a soil tillage machine. The GreenDrill seeder boxes have a capacity of either 200 l or 500 l and are easily accessible via steps.

The benefits

- ✔ Applying catch crops and fine seeds directly in combination with a soil tillage tool
- ✔ Large application rates are also possible by means of different metering rollers
- ✔ Even distribution via baffle plates
- ✔ Safe and convenient access via steps
- ✔ Precise metering with excellent lateral distribution
- ✔ Comfortable machine control via ISOBUS (GD 501) possible, thereby enabling part-area, site-specific processing of application maps
- ✔ Easy machine control via the 5.2 in-cab terminal (GD 200)



Easy operation of the GreenDrill 200 with the 5.2 in-cab terminal



- ✔ GreenDrill 200: for rigid and mounted folding Catros models and having a hopper capacity of 200 l



- ✔ GreenDrill 501: for all trailed machines having a 500 l hopper capacity and hydraulic blower fan



GreenDrill 501



FTender and XTender for Catros and Certos

Mounted front and rear hoppers for higher outputs



FTender for flexible use in combination with seeding systems and soil tillage



FTender 1600 mounted front hopper with a capacity of 1,600 l

FTender

AMAZONE offers a universal mounted front hopper for versatile use in combination with seed drills and soil tillage equipment in the shape of the FTender with a capacity of 1,600 or 2,200 l.

Thanks to their complete ISOBUS integration, the hoppers can be operated via the ISOBUS operator terminal. The application rate can even be provided via application map on a part-area, site-specific basis as well as being used in combination with GPS-Switch (SectionControl).



XTender 4200 mounted hopper with a capacity of 4,200 l

XTender

AMAZONE also offers two rear hoppers with a capacity of 4,200 l in the shape of the XTender (mounted) and the XTender-T (trailed). Both rear models also feature a divided pressurised hopper with a 50/50 split, so that two different materials, such as fertiliser and seed, can be applied simultaneously.

Advantages of conveying systems with a segmented distributor head

- ✔ Highly efficient as a result of the large hopper capacity
- ✔ Lower machine costs owing to more flexibility and more applications
- ✔ Precise working due to its completely integrated ISOBUS control
- ✔ Easy access via loading board



XTender 4200 mounted hopper with a capacity of 4,200 l with Ceus 7000-2TX

Technical data:

Catros compact disc harrows

Catros 03 mounted compact disc harrows	Catros ⁺ 2503	Catros ⁺ 3003	Catros ⁺ 3503	Catros ⁺ 4003	Catros ^{XL} 3003	Catros ^{XL} 3503	Catros ^{XL} 4003
Working width *(m)	2.50	3.00	3.50	4.00	3.00	3.50	4.00
Working speed (km/h)	12–18				12–18		
Power requirement from (kW/hp)	55/75	66/90	77/105	91/125	88/120	103/140	118/160
Disc diameter/ thickness (mm)	510/5				–		
Catros ⁺	510/5				–		
Catros ^{XL}	–				610/6		
Disc spacing (mm)	250				250		
No. of discs	2 x 10	2 x 12	2 x 14	2 x 16	2 x 12	2 x 14	2 x 16
Depth of work (cm)	Catros ⁺ 2 – 14				Catros ^{XL} 5 – 16		
Transport length with road lights (m)	2.40				3.34		
Transport width (m)	2.93	3.00	3.50	4.00	3.00	3.50	4.00
Transport height (m)	1.50				1.50		
Weight without roller (kg)	1,035	1,175	1,485	1,600	1,460	1,805	1,960
Weight (kg) (base machine, manual working depth adjustment, KWM 600)	1,475	1,690	2,082	2,275	1,980	2,400	2,630
No. of double-acting spool valves (with hydraulic depth control)	– (1)	– (1)	– (1)	– (1)	– (1)	– (1)	– (1)

*The stated working width is achieved only if all the discs are set to the same working depth.

Catros mounted compact disc harrows	Mounted models, folding			
	Catros ⁺ 4003-2	Catros ⁺ 5003-2	Catros ⁺ 6003-2	Catros ⁺ 7003-2
Working width *(m)	4.00	5.00	6.00	7.00
Working speed (km/h)	12–18			
Power requirement from (kW/hp)	91/125	110/155	130/180	154/210
Disc diameter/ thickness (mm)	510/5			
Catros ⁺	510/5			
Catros ^{XL}	–			
Disc spacing (mm)	250			
No. of discs	2 x 16	2 x 20	2 x 24	2 x 28
Depth of work (cm)	Catros ⁺ 2 – 14			
Transport length with road lights from (m)	2.80			
Transport width (m)	3.00			
Transport height (m)	2.40	2.90	3.40	3.90
Weight without roller from (kg)	2,000	2,400	3,000	3,470
Weight from (kg) (base machine, manual working depth adjustment, KWM 600)	2,700	3,250	3,900	4,450
No. of double-acting spool valves (with hydraulic depth control)	1 (2)			

*The stated working width is achieved only if all the discs are set to the same working depth.

Illustrations, content and technical data are not binding and may differ depending on the level of equipment. Country-specific road traffic regulations apply and must be complied with, meaning that special approval may be required. The permissible axle loads and total weights of the tractor should be checked. Not all the listed combination options are possible with all tractor manufacturers.

Catros-2TS trailed compact disc harrows	Catros⁺ 4003-2TS	Catros⁺ 5003-2TS	Catros⁺ 6003-2TS	Catros⁺ 7003-2TS	Catros^{XL} 5003-2TS	Catros^{XL} 6003-2TS
Working width *(m)	4.00	5.00	6.00	7.00	5.00	6.00
Working speed (km/h)	12 – 18					
Power requirement from (kW/hp)	91/125	110/150	130/180	154/210	147/200	176/240
Disc diameter/ thickness (mm)	510/5					
Catros ⁺	510/5					
Catros ^{XL}	–					
Disc spacing (mm)	250					
No. of discs	2 x 16	2 x 20	2 x 24	2 x 28	2 x 20	2 x 24
Depth of work (cm)	Catros ⁺ 2 – 14				Catros ^{XL} 5 – 16	
Linkage	Lower linkage + ball coupling and towing eye					
Transport length with road lights (m)	6.60				6.88	
Transport width (m)	3.00				2.95	
Transport height (m)	2.70	3.20	3.70	4.00	3.20	3.70
Weight without roller (kg)	3,700	3,950	4,550	4,950	4,875	5,210
Weight from (kg) (base machine, manual working depth adjustment, KWM 600)	4,440	4,845	5,720	6,320	5,950	6,440
No. of double-acting spool valves (with hydraulic depth control)	2 (3)				2 (3)	

*The stated working width is achieved only if all the discs are set to the same working depth.

Catros⁺-2TX and Catros⁺ 12003-2TS trailed compact disc harrows	Catros⁺ 7003-2TX	Catros⁺ 8003-2TX	Catros⁺ 9003-2TX	Catros^{XL} 7003-2TX	Catros^{XL} 8003-2TX	Catros⁺ 12003-2TS
Working width *(m)	7.00	8.00	9.00	7.00	8.00	12.00
Working speed (km/h)	12 – 18			12 – 18		12 – 18
Power requirement from (kW/hp)	154/210	176/240	198/270	206/280	235/320	265/360
Disc diameter/ thickness (mm)	510/5					
Catros ⁺	510/5					
Catros ^{XL}	–					
Disc spacing (mm)	250			250		250
No. of discs	2 x 28	2 x 32	2 x 36	2 x 28	2 x 32	2 x 48
Depth of work (cm)	Catros ⁺ 2 – 14			Catros ^{XL} 5 – 16		Catros ⁺ 2 – 14
Linkage	Lower linkage + ball coupling and towing eye					
Transport length with road lights (m)	8.65			9.01		6.90
Transport width (m)	3.00			3.00		
Transport height (m)	3.45	3.95	4.00	3.65	3.85	4.00
Weight without roller (kg)	6,595	6,895	7,410	7,265	7,655	10,850
Weight from (kg) (base machine and KWM 600)	7,840	8,295	9,020	8,510	9,055	12,500
No. of double-acting spool valves (with hydraulic depth control)	2 (3)			2 (3)		3 (4)

*The stated working width is achieved only if all the discs are set to the same working depth.

Illustrations, content and technical data are not binding and may differ depending on the level of equipment. Country-specific road traffic regulations apply and must be complied with, meaning that special approval may be required. The permissible axle loads and total weights of the tractor should be checked. Not all the listed combination options are possible with all tractor manufacturers.

Technical data:

Certos heavy compact disc harrows

Certos-2TX heavy trailed compact disc harrows	Certos 5002-2TX	Certos 6002-2TX	Certos 7002-2TX
Execution	folding/trailed	folding/trailed	folding/trailed
Working width *(m)	4.90	6.00	7.00
Working speed (km/h)	10 – 15		
Transport speed (km/h)	40		
Disc diameter/ thickness (mm) Certos (serrated)	660/6		
No. of discs	28	36	40
Disc spacing (mm)	350		
Depth of work (cm)	7 – 20		
Power requirement from/to (HP/m)	200 – 300	250 – 400	> 350
Transport length (m)	8.55	8.55	8.55
Transport width (m)	3.00		
Transport height (m)	3.34	3.85	3.99
Total weight (kg) (base machine + KWM 600)	6,935	8,150	8,820
Actual support load (kg)	1,500	1,700	1,700

*The stated working width is achieved only if all the discs are set to the same working depth.



Certos 6002-2TX

Illustrations, content and technical data are not binding and may differ depending on the level of equipment. Country-specific road traffic regulations apply and must be complied with, meaning that special approval may be required. The permissible axle loads and total weights of the tractor should be checked. Not all the listed combination options are possible with all tractor manufacturers.

Technical data:

FTender mounted front hopper and XTender rear hopper

FTender mounted front hopper	FTender 1600	FTender 1600 with front tyre packer	FTender 2200	FTender 2200 with front tyre packer	FTender 2200 C
Hopper capacity(l)	1,600		2,200		
No. of metering units	1				2
No. of spool valves required	1 single-acting (front) with pressure-free return				
Oil flow from (l/min)	28				
Attachment to tractor	3-point linkage Cat. 3/4N				
Permissible total weight (kg)	3,421	3,421	4,118	4,118	4,203
Overall width (m)	2.504	2.504	2.504	2.504	
Fill height (m)	1.402	1.581*/1.737	1.582	1.762*/1.917	
Overall length (m)	1.698	2.093	1.698	2.093	
Unladen weight (kg)	526	1,111	661	1,246	783

*Packer in transport/working position

XTender rear hopper	XTender 4200	XTender-T 4200 (only available in Russia)
Hopper capacity(l)	4,200	
Maximum pulling power (HP)	600	
Ratio of hopper split	50/50	
No. of spool valves required	1 single-acting spool valve with pressure-free return	1 single-acting spool valve with pressure-free return, 1 double-acting
Attachment to tractor	3-point linkage Cat. 3/4N	Lower linkage ball coupling towing eye
Machine mounting	Lower linkage Cat. 3/4N	Lower linkage ball coupling towing eye
Permissible support load on linkage (kg)		
Lower linkage	3,000	4,000
Ball coupling	–	4,000
Flange drawbar	–	3,500
Permissible total weight (kg)	7,200	12,000
Overall width (m)	2.90	2.90
Fill height (m)	2.12	2.80
Overall length (m)	1.98	6.00
Unladen weight (kg)	1,300	3,400

Illustrations, content and technical data are not binding and may differ depending on the level of equipment. Country-specific road traffic regulations apply and must be complied with, meaning that special approval may be required. The permissible axle loads and total weights of the tractor should be checked. Not all the listed combination options are possible with all tractor manufacturers.



AMAZONE



Illustrations, content and technical data are not binding and may differ depending on the level of equipment. Country-specific road traffic regulations apply and must be complied with, meaning that special approval may be required. The permissible axle loads and total weights of the tractor should be checked. Not all the listed combination options are possible with all tractor manufacturers.



AMAZONEN-WERKE H. DREYER SE & Co. KG
P. O. Box 51 · 49202 Hasbergen-Gaste/Germany
Phone +49 (0)5405 501-0 · Fax +49 (0)5405 501-193